

Exterior Systems













2025 Illustrated Price List

Effective April 1, 2025

CANADA



CONTENTS

	Exterior applications process	7
	Exterior applications details	8 - 9
	Drainage membranes	10 - 11
	Paver support system	12 - 15
	Modular screed system	16 - 17
	Balcony and terrace profiles	18 - 21
	Floor profiles	22 - 25
	Wall profiles	26 - 29
	Stair profiles	30 - 32
	Movement joint profiles	33 - 34
	Setting materials	35 - 36
	Tools	37

DRAINAGE MEMBRANES



Schluter®-TROBA-PLUS
Page 11



Schluter®-DITRA-DRAIN
Page 11

PAVER SUPPORT SYSTEM



Schluter®-TROBA-LEVEL-PL 10
Page 13



Schluter®-TROBA-LEVEL-PLA 30
Page 13



Schluter®-TROBA-LEVEL-AP 1
Page 13



Schluter®-TROBA-LEVEL-PLV 60
Page 14

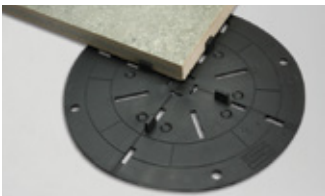

Schluter®-TROBA-LEVEL-LV 3
Page 14



Schluter®-TROBA-LEVEL-PLA 70
Page 14



Schluter®-TROBA-LEVEL-PLS 6
Page 15



Schluter®-TROBA-ZFK
Page 15

MODULAR SCREED SYSTEM



Schluter®-BEKOTEC-DRAIN
Page 17



Schluter®-BEKOTEC-BRS
Page 17



Schluter®-BEKOTEC-BRSK
Page 17

BALCONY AND TERRACE PROFILES



Schluter®-BARA-RWL
Page 19



Schluter®-BARA-RW
Page 20



Schluter®-BARA-RAK
Page 21



Schluter®-BARA-ESOT
Page 21

FLOOR PROFILES



Schluter®-**SCHIENE**
Page 23

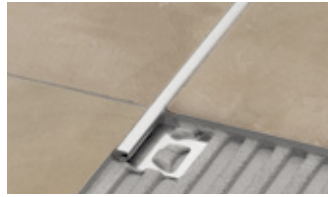

Schluter®-**DECO**
Page 24

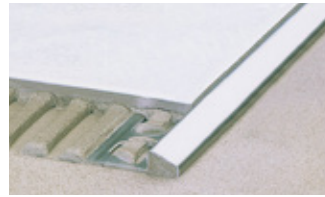

Schluter®-**RENO-U**
Page 25

WALL PROFILES



Schluter®-**JOLLY**
Page 26



Schluter®-**SCHIENE**
Page 27



Schluter®-**RONDEC**
Page 28



Schluter®-**QUADEC**
Page 29

STAIR PROFILES

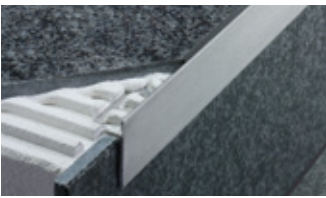

Schluter®-**SCHIENE-STEP**
Page 30



Schluter®-**TREP-FL**
Page 31

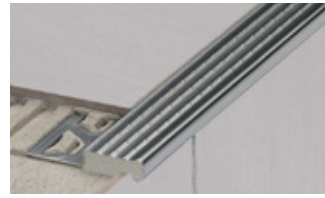

Schluter®-**TREP-E**
Page 31



Schluter®-**TREP-EK**
Page 32



Schluter®-**TREP-EFK**
Page 32

MOVEMENT JOINT PROFILES



Schluter®-**DILEX-EDP**
Page 33



Schluter®-**DILEX-KSN**
Page 34



Schluter®-**DILEX-KSA**
Page 34

SETTING MATERIALS



Schluter®-SET
Page 36



Schluter®-ALL-SET
Page 36



Schluter®-FAST-SET
Page 36

TOOLS



Schluter®-PROCUT-TSM
Page 37



Schluter®-TROWEL
Page 37



Schluter®-DITRA-ROLLER
Page 37





© Villeroy & Boch

EXTERIOR APPLICATIONS PROCESS

Schluter®-Systems has years of experience with exterior applications. Strict adherence to Schluter's installation requirements, Schluter's Exterior Applications Checklist, and industry standards are required to receive warranty coverage and to ensure the success of your exterior installation.

Prior to the installation of your exterior application, Schluter®-Systems requires that it completes a thorough evaluation of your exterior project to ensure that each application will meet our specified requirements and to ensure warranty coverage. Please contact Schluter®-Systems' customer service or your Territory Manager for more information.

EXTERIOR APPLICATIONS DETAILS

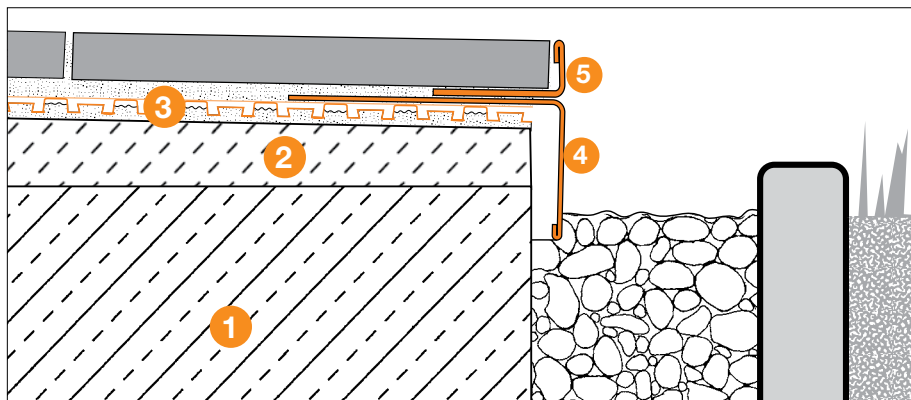

Thin - Concrete on Grade

- 1 Concrete - slab on grade
- 2 Sloped screed (2%)
- 3 Schluter®-DITRA-DRAIN
- 4 Schluter®-BARA-RW
- 5 Schluter®-SCHIENE (optional)

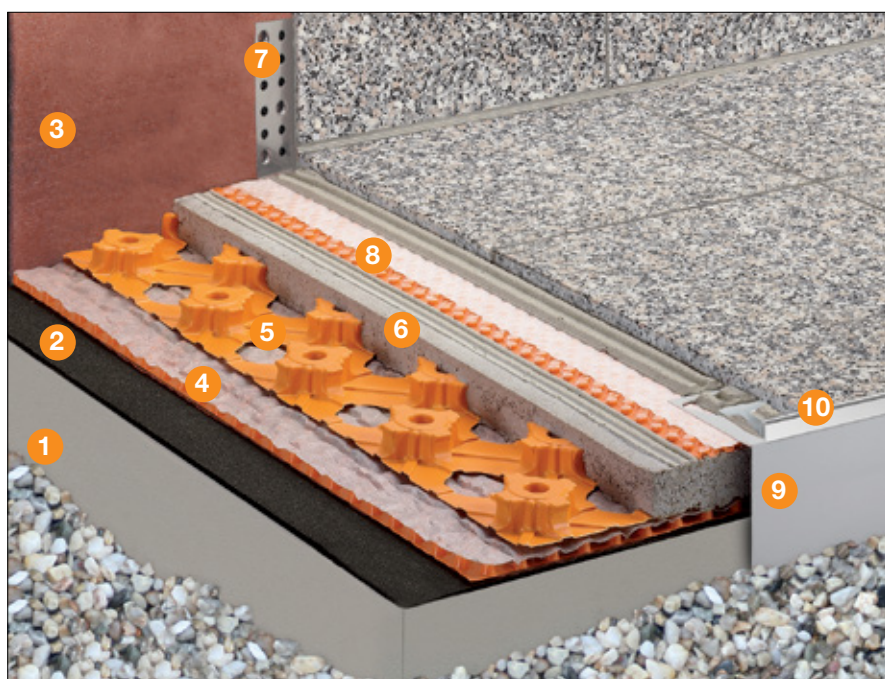

Thick - Concrete on Grade

- 1 Sloped structure (2%)
- 2 Primary roofing membrane (optional)
- 3 Schluter®-BEKOTEC-BRS
- 4 Schluter®-TROBA-PLUS
- 5 Schluter®-BEKOTEC-DRAIN
- 6 Mortar bed
- 7 Schluter®-BARA-ESOT (required if using a primary roofing membrane)
- 8 Schluter®-DITRA-DRAIN
- 9 Schluter®-BARA-RW
- 10 Schluter®-SCHIENE (optional)

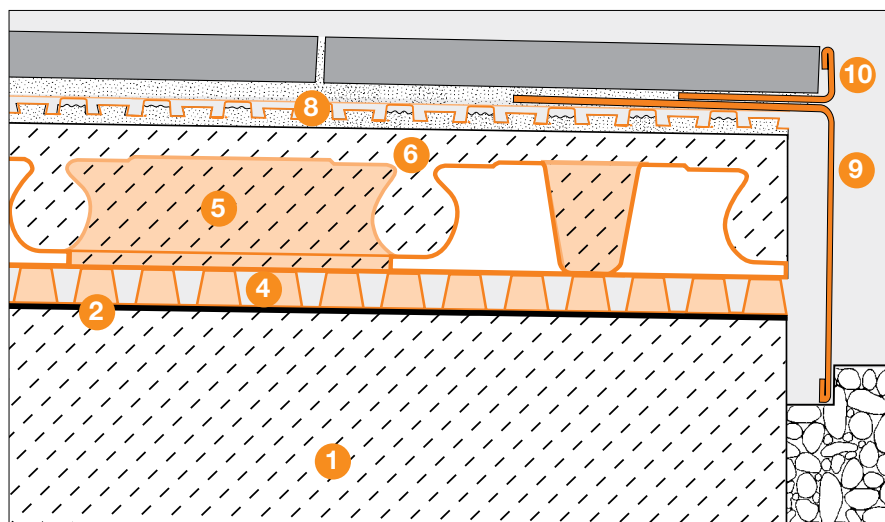



Elevated Thick System

- 1 Sloped structure (2%)
- 2 Schluter®-BARA-RAK
- 3 Primary roofing membrane
- 4 Schluter®-BEKOTEC-BRS
- 5 Schluter®-TROBA-PLUS
- 6 Schluter®-BEKOTEC-DRAIN
- 7 Mortar bed
- 8 Schluter®-BARA-ESOT
- 9 Schluter®-DITRA-DRAIN
- 10 Schluter®-BARA-RW

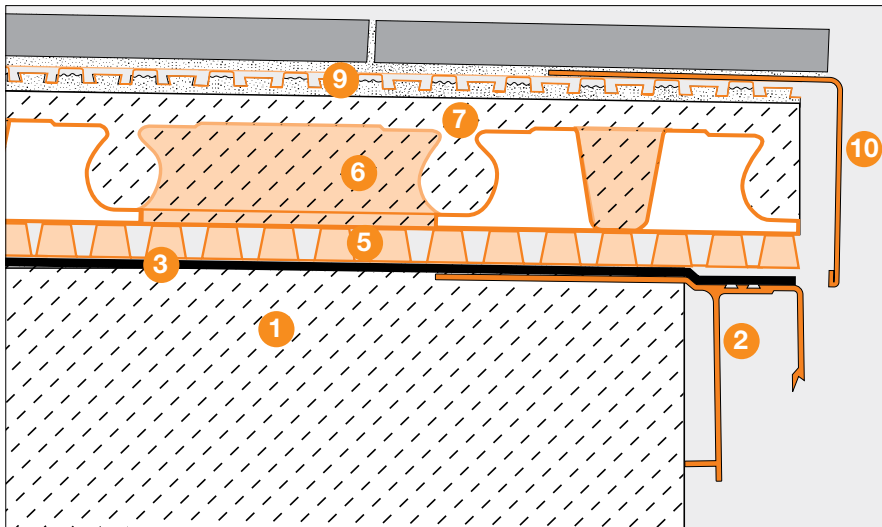

Note: To ensure proper drainage of the assembly, recess the anchoring leg of Schluter®-BARA profiles in the mortar to remain flush for application of primary waterproofing membrane.



Please refer to the Exterior Application Data Sheet corresponding to your assembly for complete details and warranty information.



DRAINAGE MEMBRANES





Schluter®-TROBA-PLUS

Schluter®-TROBA-PLUS is a durable sub-surface drainage system that permits water to drain off freely and reliably. The closely positioned, cone-shaped studs are covered by a water permeable filter fabric. They serve to support the floor covering over the entire surface, thus creating a continuous drainage area above the waterproofing layer.

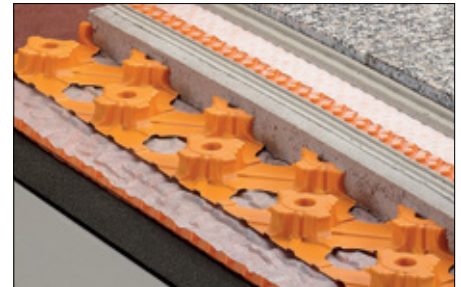
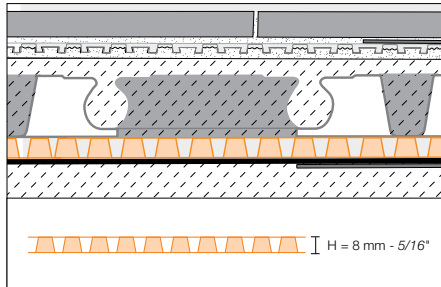

Schluter®-TROBA-PLUS			
Sub-surface drainage system			
Item No.	Dimensions	\$ / ft ² *	\$ / Roll
TROBA-PLUS 8	1 m x 12.5 m = 12.5 m ² 3' 3" x 41' = 134.5 ft ²	3.18	427.04

* The price per square foot is for estimation purposes only. Please order using the price per roll.

Schluter®-DITRA-DRAIN

Schluter®-DITRA-DRAIN is a drainage membrane designed for use within thin-bed ceramic and stone tile assemblies in exterior applications. It consists of a studded polyethylene sheet with a laminated polypropylene filter fabric. DITRA-DRAIN provides uncoupling and drainage for use in a variety of exterior applications, including exterior floors, patios, walkways and balconies.

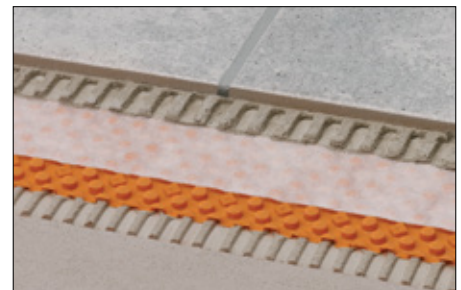
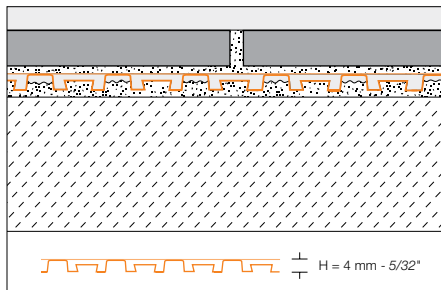

Schluter®-DITRA-DRAIN			
Thin-bed drainage membrane (4 mm - 5/32")			
Item No.	Dimensions	\$ / ft ² *	\$ / Roll
DITRA-DRAIN 10M	1 m x 10 m = 10 m ² - 3' 3" x 33' = 108 ft ²	3.54	382.17
DITRA-DRAIN 25M	1 m x 25 m = 25 m ² - 3' 3" x 82' = 269 ft ²	3.30	887.99

* The price per square foot is for estimation purposes only. Please order using the price per roll.

Schluter®-DITRA-DRAIN-STU			
Self adhesive seaming tape			
Item No.	Dimensions	\$ / ft *	\$ / Roll
STUVKB90/5M	90 mm x 5 m - 3-1/2" x 16' 5"	3.50	57.49
STUVKB90/30M	90 mm x 30 m - 3-1/2" x 98' 5"	3.09	303.77

* The price per foot is for estimation purposes only. Please order using the price per roll.



PAVER SUPPORT SYSTEM





Schluter®-TROBA-LEVEL-PL 10

Schluter®-TROBA-LEVEL-PL 10 stackable paver supports are designed to support tile pavers of different formats and thicknesses. The 1/8" (3 mm) joint spacers enable a uniform joint appearance while protecting against lateral movements in the covering. TROBA-LEVEL-PL 10 can be stacked up to heights of 7-7/8" (200 mm) and can also be combined with other TROBA-LEVEL paver supports.

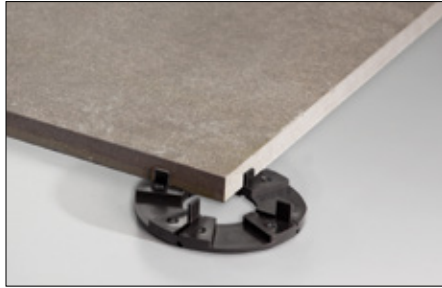

Schluter®-TROBA-LEVEL-PL 10				
Stackable paver support (10 mm - 3/8")				
H = mm - in.	Item No.	Qty. / Kit	\$ / Unit	\$ / Kit
10 - 3/8	TL PL 10/10	10	4.13	41.28

Schluter®-TROBA-LEVEL-PLA 30

Schluter®-TROBA-LEVEL-PLA 30 stackable paver support extensions can be inserted between two TROBA-LEVEL-PL 10 stackable paver supports for a more economical way to achieve assembly heights of 2" (50 mm) or greater.



Schluter®-TROBA-LEVEL-PLA 30				
Stackable paver support extension				
H = mm - in.	Item No.	Qty. / Kit	\$ / Unit	\$ / Kit
30 - 1-3/16	TL PLA 30/10	10	4.78	47.79

Schluter®-TROBA-LEVEL-AP 1

Schluter®-TROBA-LEVEL-AP 1 leveling shims are used to level the tile surface by adjusting the corners of each tile paver. TROBA-LEVEL-AP 1 leveling shims are designed to lock in between the spacer tabs of the TROBA-LEVEL-LV 3, TROBA-LEVEL-PL 10, and TROBA-LEVEL-PLV 60 paver supports. The TROBA-LEVEL-AP 1 leveling shims can be stacked up to 10 shims high under each corner of the tile paver to compensate for variations in the substrate and/or paver thickness.



Schluter®-TROBA-LEVEL-AP 1				
Leveling shim				
H = mm - in.	Item No.	Qty. / Kit	\$ / Unit	\$ / Kit
1 - 1/32	TL AP 1	250	0.25	62.85



Schluter®-TROBA-LEVEL-PLV 60

Schluter®-TROBA-LEVEL-PLV 60 pre-assembled, adjustable paver supports can be variably adjusted from 2-3/8" to 5-1/8" (60 - 130 mm) using the adjustment ring and two opposing threads. The joint spacer configuration of the TROBA-LEVEL-PLV 60 paver support enables stacking in combination with TROBA-LEVEL-PL 10 and -PLA 30. If necessary, TROBA-LEVEL-AP 1 leveling plates can be used for precision adjustment and leveling of the tile surface.



Schluter®-TROBA-LEVEL-PLV 60				
Adjustable paver support				
H = mm - in.	Item No.	Qty. / Kit	\$ / Unit	\$ / Kit
60 - 130 2-3/8 - 5-1/8	TL PLV 60/6	6	15.92	95.49

Schluter®-TROBA-LEVEL-LV 3

Schluter®-TROBA-LEVEL-LV 3 stackable paver supports are intended for low assembly heights. The supports can be cut for perimeter applications and feature 1/8" (3 mm) joint spacers. The joint spacer configuration of the TROBA-LEVEL-LV 3 paver support enables stacking in combination with TROBA-LEVEL-PL 10 and -PLA 30.

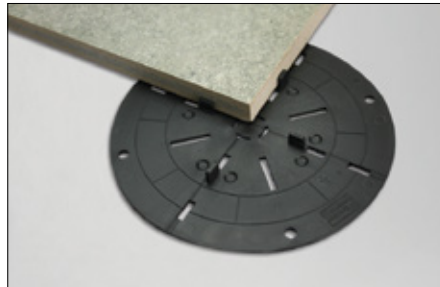

Schluter®-TROBA-LEVEL-LV 3				
Stackable paver support (3 mm - 1/8")				
H = mm - in.	Item No.	Qty. / Kit	\$ / Unit	\$ / Kit
3 - 1/8	TL LV 3/10	10	7.44	74.38

Schluter®-TROBA-LEVEL-PLA 70

Schluter®-TROBA-LEVEL-PLA 70 adjustable paver support height extensions are designed to be added to the TROBA-LEVEL-PLV 60 adjustable paver supports between the height adjustment ring and the base plate. Multiple TROBA-LEVEL-PLA 70 paver support extensions can be used to reach the desired height (recommended maximum height: 15" [381 mm]).



Schluter®-TROBA-LEVEL-PLA 70				
Adjustable paver support extension				
H = mm - in.	Item No.	Qty. / Kit	\$ / Unit	\$ / Kit
70 - 2-3/4	TL PLA 70/6	6	10.47	62.79



Schluter®-TROBA-LEVEL-PLS 6

Schluter®-TROBA-LEVEL-PLS 6 protective pads provide additional protection to the waterproofing membrane under the base plates of TROBA-LEVEL-LV 3, TROBA-LEVEL-PL 10, or TROBA-LEVEL-PLV 60 paver supports. The TROBA-LEVEL-PLS 6 protective pads feature four perforated tabs designed to maintain the position of the paver support on the pad.

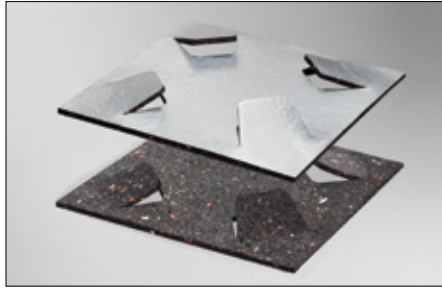

Schluter®-TROBA-LEVEL-PLS 6				
Protective pad				
H = mm - in.	Item No.	Qty. / Kit	\$ / Unit	\$ / Kit
6 - 1/4	TL PLS 6	10	3.90	39.04

Schluter®-TROBA-ZFK

Schluter®-TROBA-ZFK joint spacers ensure a uniform joint appearance for self-supporting porcelain tiles, natural stone, or concrete pavers installed directly on sand, gravel, or crushed stone beds. The joint width is 1/8" (3 mm), and the joint spacer height is 9/16" (15 mm). When thicker pavers are being installed, a joint spacer height of 1-3/16" (30 mm) can be achieved by snapping two joint spacers together.



Schluter®-TROBA-ZFK				
Joint spacer (3 mm - 1/8")				
H = mm - in.	Item No.	Qty. / Kit	\$ / Unit	\$ / Kit
15 - 9/16	TZ FK 3	50	0.47	23.72



MODULAR SCREED SYSTEM





Schluter®-BEKOTEC-DRAIN

BEKOTEC-DRAIN is a modular screed system that is used to create continuous screed surfaces without control joints or reinforcement and can also accommodate hydronic radiant heating tubes. It produces a permanent flooring assembly that is free from internal stresses by confining the shrinkage and curing stresses to smaller modules, which controls deformations such as curling and continuous cracks that are common in traditional screeds.

BEKOTEC-DRAIN is 29/32" (23 mm)-thick and is made of polystyrene foil with evenly spaced openings and interconnected drainage channels. It is specifically designed for use with ceramic tile and natural stone in exterior applications over a primary roofing membrane and Schluter®-TROBA-PLUS drainage system.

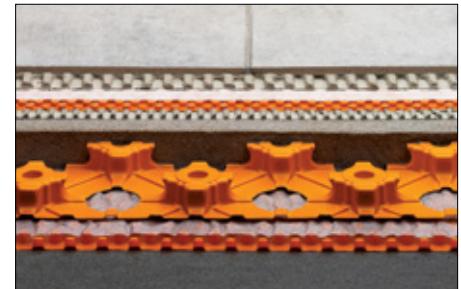
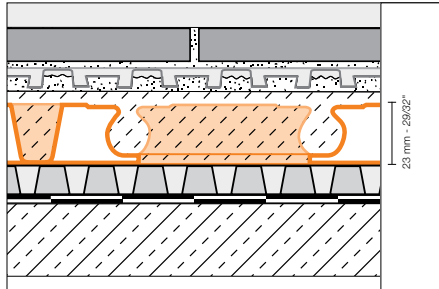

Schluter®-BEKOTEC-DRAIN			
Studded screed panel (23 mm - 29/32")			
Item No.	Dimensions/Sheet	Packaging	\$ / Box
EN23FD10	120 x 90 cm = 1.08 m ² 47-1/4" x 35-7/16" = 11.63 ft ²	10 sheets / box	444.83

BRS



Schluter®-BEKOTEC-BRS		
Edge strip for conventional screed		
Item No.	Dimensions	\$ / Roll
BRS 810	50 m roll: 10 cm wide x 8 mm thick 164' roll: 4" wide x 5/16" thick	115.19

BRSK



Schluter®-BEKOTEC-BRSK		
Edge strip for conventional screed, with adhesive strip		
Item No.	Dimensions	\$ / Roll
BRSK 810	50 m roll: 10 cm wide x 8 mm thick 164' roll: 4" wide x 5/16" thick	149.73



BALCONY AND TERRACE PROFILES





Schluter®-BARA-RWL

Schluter®-BARA-RWL is a color-coated aluminum edging profile with drainage holes for the perimeters of balconies and terraces. The profile is particularly suitable for balcony and terrace coverings loosely laid on gravel or elevated sub-structures.



Note: Limited quantities are kept in inventory. Please contact Customer Service for availability. Items not in stock require 6-8 weeks delivery time.

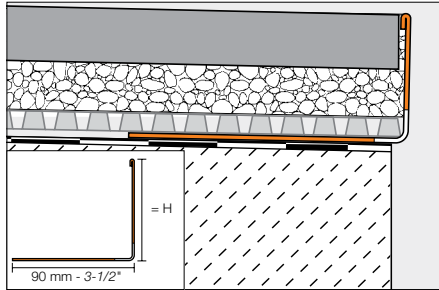

*Color Codes



* To complete the item number, add the **color** code (e.g., RWL 15 **PG**).

Schluter®-BARA-RWL		
Length = 2.5 m - 8' 2-1/2"	Color-coated aluminum	
H = mm - in.	Item No.	\$ / Length
15 - 9/16	RWL 15 + color*	78.03
25 - 1	RWL 25 + color*	82.70
30 - 1-3/16	RWL 30 + color*	84.62
40 - 1-9/16	RWL 40 + color*	90.23
55 - 2-3/16	RWL 55 + color*	98.64
75 - 3	RWL 75 + color*	109.91
95 - 3-3/4	RWL 95 + color*	121.19
120 - 4-3/4	RWL 120 + color*	152.29
150 - 6	RWL 150 + color*	169.16

Note: The anchoring leg of **Schluter®-BARA-RWL** is available with a special radius perforation so that the profile can be used to form curves.

- Price surcharge: \$2.27 per foot
- Available in all materials
- For delivery time, please call Customer Service
- Item No.: R / Profile No. (e.g., R/RWL 15 PG)





Schluter®-BARA-RW

Schluter®-BARA-RW is an angular profile made of stainless steel or color-coated aluminum for finishing the exposed perimeters of balconies and terraces.



Note: Limited quantities are kept in inventory. Please contact Customer Service for availability. Items not in stock require 6-8 weeks delivery time.

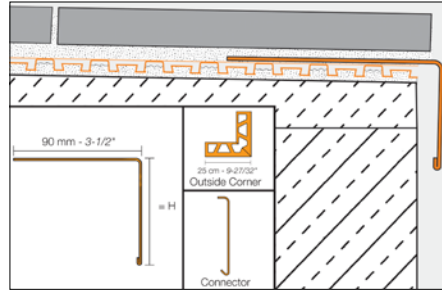

Outside corner

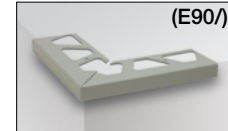

Connector

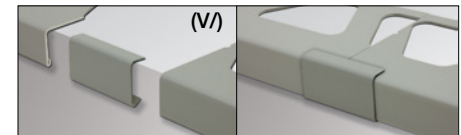

***Color Codes**

Bright white	Classic grey	Metallic grey	Anthracite grey	Black brown

* To complete the item number, add the **color** code (e.g., RW 15 **SB**).

Schluter®-BARA-RW						
Length = 2.5 m - 8' 2-1/2"		Color-coated aluminum				
H = mm - in.	Profile		Outside corner 90°		Connector	
	Item No.	\$ / Length	Item No.	\$ / Unit	Item No.	\$ / Unit
15 - 9/16	RW 15 + color*	78.03	E90/RW 15 + color*	42.87	V/RW 15 + color*	8.66
25 - 1	RW 25 + color*	82.70	E90/RW 25 + color*	43.92	V/RW 25 + color*	8.66
30 - 1-3/16	RW 30 + color*	84.62	E90/RW 30 + color*	44.87	V/RW 30 + color*	8.66
40 - 1-9/16	RW 40 + color*	90.23	E90/RW 40 + color*	45.82	V/RW 40 + color*	8.66
55 - 2-3/16	RW 55 + color*	98.64	E90/RW 55 + color*	47.94	V/RW 55 + color*	8.66
75 - 3	RW 75 + color*	109.91	E90/RW 75 + color*	50.53	V/RW 75 + color*	8.66
95 - 3-3/4	RW 95 + color*	121.19	E90/RW 95 + color*	53.20	V/RW 95 + color*	8.66
120 - 4-3/4	RW 120 + color*	152.29	E90/RW 120 + color*	72.72	V/RW 120 + color*	8.66
150 - 6	RW 150 + color*	169.16	E90/RW 150 + color*	76.68	V/RW 150 + color*	8.66

Schluter®-BARA-RWE						
Length = 2.5 m - 8' 2-1/2"		Stainless steel 304 (1.4301 = V2A) (E)				
H = mm - in.	Profile		Outside corner 90°		Connector	
	Item No.	\$ / Length	Item No.	\$ / Unit	Item No.	\$ / Unit
15 - 9/16	RW 15 E	125.58	E90/RW 15 E	61.32	V/RW 15 E	10.00
25 - 1	RW 25 E	130.39	E90/RW 25 E	62.52	V/RW 25 E	10.00
30 - 1-3/16	RW 30 E	138.13	E90/RW 30 E	64.47	V/RW 30 E	10.00
40 - 1-9/16	RW 40 E	144.89	E90/RW 40 E	64.73	V/RW 40 E	10.00
55 - 2-3/16	RW 55 E	160.36	E90/RW 55 E	70.38	V/RW 55 E	10.00
75 - 3	RW 75 E	179.66	E90/RW 75 E	75.58	V/RW 75 E	10.00
95 - 3-3/4	RW 95 E	198.98	E90/RW 95 E	94.61	V/RW 95 E	10.00
120 - 4-3/4	RW 120 E	222.14	E90/RW 120 E	100.91	V/RW 120 E	10.00
150 - 6	RW 150 E	252.00	E90/RW 150 E	108.75	V/RW 150 E	10.00

Note: The anchoring leg of **Schluter®-BARA-RW/-RWE** is available with a special radius perforation so that the profile can be used to form curves.

- Price surcharge: \$2.27 per foot
- Available in all materials
- Color-coated aluminum requires a relatively large bending radius
- For delivery time, please call Customer Service
- Item No.: R / Profile No. (e.g., R/RW 15 E)





Schluter®-BARA-RAK

Schluter®-BARA-RAK is a color-coated aluminum balcony edging profile with a drip lip. It is fitted to the edges of finished sloped surfaces to form both an edging and a drip lip.



Note: Limited quantities are kept in inventory. Please contact Customer Service for availability. Items not in stock require 6-8 weeks delivery time.

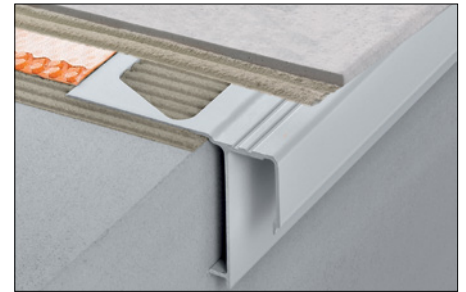
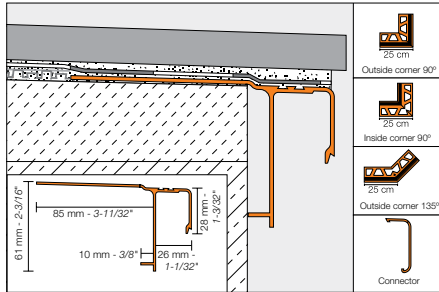

***Color Codes**

BW	PG	GM	AG	SB
Bright white	Classic grey	Metallic grey	Anthracite grey	Black brown

* To complete the item number, add the **color** code (e.g., RAK 50 **SB**).

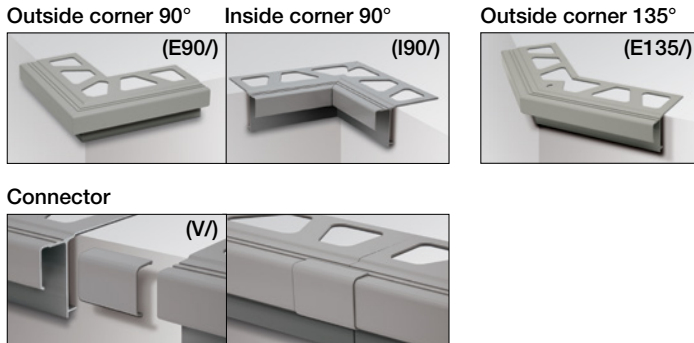

Schluter®-BARA-RAK							
Length = 2.5 m - 8' 2-1/2"	Color-coated aluminum						
	Profile	\$ / Length	Outside corner 90°	Inside corner 90°	\$ / Unit	Outside corner 135°	\$ / Unit
	RAK 50 + color *	142.07	E90/RAK 50 + color *	I90/RAK 50 + color *	75.77	E135/RAK 50 + color *	82.66
Connector	V/RT 30 + color *						5.02

Schluter®-BARA-ESOT

Schluter®-BARA-ESOT is a skirting support profile made of stainless steel for use in applications where no load-bearing substrate is available to support the skirting tiles.



Note: Limited quantities are kept in inventory. Please contact Customer Service for availability. Items not in stock require 6-8 weeks delivery time.

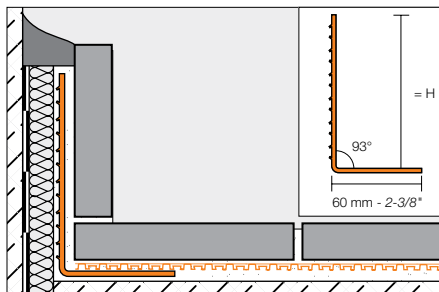

Schluter®-BARA-ESOT			
Length = 2.5 m - 8' 2-1/2"	Stainless steel 304 (1.4301 = V2A) (E)		
H = mm - in.	Item No.		\$ / Length
60 - 2-3/8	ESOT 60		74.32
110 - 4-3/8	ESOT 110		95.61



FLOOR, WALL, STAIR, AND MOVEMENT JOINT PROFILES





Schluter®-SCHIENE

Schluter®-SCHIENE features an 87 degree angle and is designed to provide edge-protection and act as a decorative edging for tile coverings. SCHIENE in stainless steel, as listed on this page, is suitable for use in exterior applications.

Note: Also available in stainless steel 316L (1.4404 = V4A). Contact Customer Service for pricing and availability.

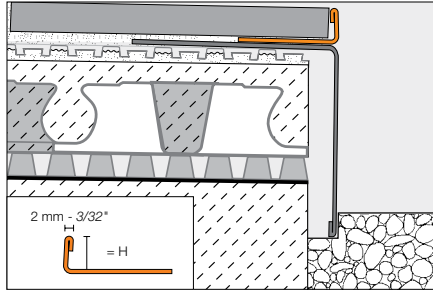

Schluter®-SCHIENE				
Length = 2.5 m - 8' 2-1/2"		Stainless steel 304 (1.4301 = V2A) (E)		Brushed stainless steel 304 (1.4301 = V2A) (EB)
H = mm - in.	Item No.	\$ / Length	Item No.	\$ / Length
2 - 3/32	E 20	35.58	-	-
3 - 1/8	E 30	39.12	-	-
4.5 - 3/16	E 45	45.02	-	-
6 - 1/4	E 60	47.09	E 60 EB	56.50
7 - 9/32	E 70	48.10	-	-
8 - 5/16	E 80	47.51	E 80 EB	58.71
9 - 11/32	E 90	50.39	-	-
10 - 3/8	E 100	48.78	E 100 EB	60.30
11 - 7/16	E 110	49.73	E 110 EB	62.64
12.5 - 1/2	E 125	50.41	E 125 EB	62.88
14 - 17/32	E 140	55.82	-	-
15 - 9/16	E 150	62.30	-	-
16 - 5/8	E 160	63.22	-	-
17.5 - 11/16	E 175	64.02	-	-
20 - 3/4	E 200	66.72	-	-
22.5 - 7/8	E 225	69.42	-	-
25 - 1	E 250	71.99	-	-
30 - 1-3/16	E 300	77.41	-	-
Length = 3.05 m - 10'		Stainless steel 304 (1.4301 = V2A) (E)		
H = mm - in.	Item No.	\$ / Length		
8 - 5/16	E 80/300	59.34		
10 - 3/8	E 100/300	60.94		
12.5 - 1/2	E 125/300	62.99		

Note: The anchoring leg of Schluter®-SCHIENE is available with a special radius perforation so that the profile can be used to form curves.

- Price surcharge: \$0.70 per foot
- Stocked sizes: 6, 8, 10, 11, and 12.5 mm
- Item No.: R / Profile No. (e.g., R/E 80)
- For delivery time on other sizes, please call Customer Service





Schluter®-DECO

Schluter®-DECO is designed to provide decorative lines within tile coverings and edge protection at transitions from tile coverings to other same-height surface coverings. The profile features a 1/4" (6 mm)-wide visible surface. DECO in stainless steel, as listed on this page, is suitable for use in exterior applications.

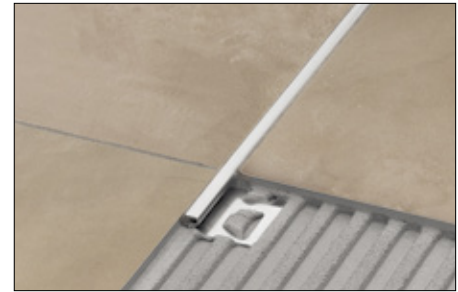
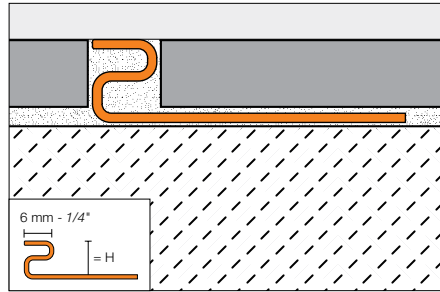

Schluter®-DECO			
Length = 2.5 m - 8' 2-1/2"		Stainless steel 304 (1.4301 = V2A) (E)	
H = mm - in.		Item No.	\$ / Length
8 - 5/16		E 80 D	60.81
9 - 11/32		E 90 D	61.48
10 - 3/8		E 100 D	62.52
11 - 7/16		E 110 D	63.32
12.5 - 1/2		E 125 D	64.76
14 - 17/32		E 140 D	67.50
16 - 5/8		E 160 D	67.80
18.5 - 23/32		E 185 D	70.20
21 - 13/16		E 210 D	74.32
25 - 1		E 250 D	78.39
30 - 1-3/16		E 300 D	80.51



Schluter®-RENO-U

Schluter®-RENO-U is designed to protect tile edges and provide a smooth transition between tile coverings and floor coverings at lower elevations or finished concrete. The sloped surface eliminates trip hazards and the leading edge of the profile abuts the lower surface covering. RENO-U in stainless steel, as listed on this page, is suitable for use in exterior applications.

ADA-Compliant

Note: When leading edge abuts lower surface covering, sizes 20 mm (3/4") and 17.5 mm (11/16") are not ADA-compliant. When leading edge rests on top of lower surface covering, sizes 20 mm (3/4"), 15 mm (9/16"), and 17.5 mm (11/16") are not ADA-compliant.

Technical Note: ADA requirements regarding transitions between surfaces of different heights:

- Up to 6 mm (1/4") - no special requirements
- 6 mm (1/4") to 12.5 mm (1/2") - slope ratio, 1:2
- More than 12.5 mm (1/2") - slope ratio, 1:12

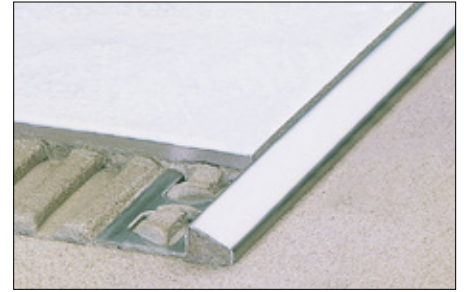
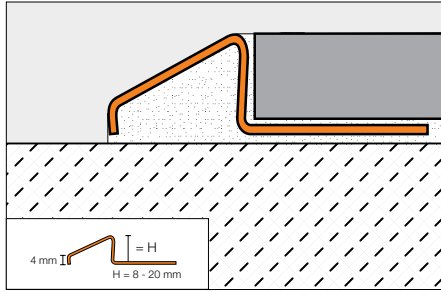
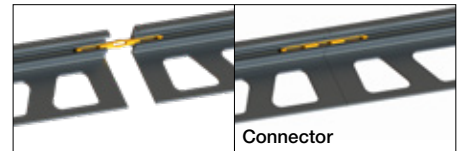
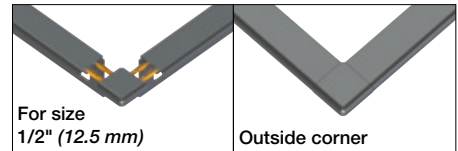
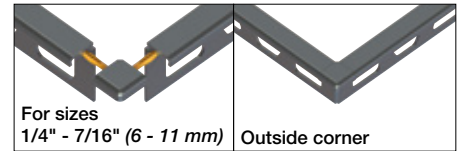
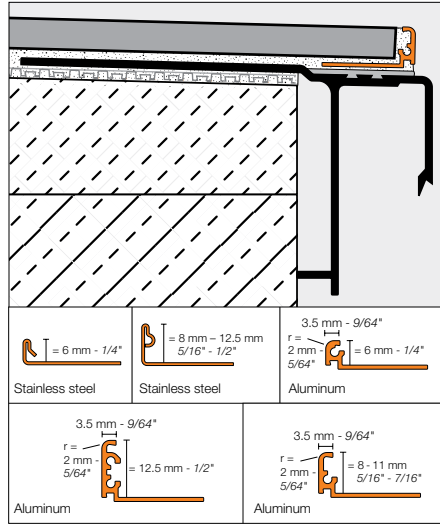

Diagram Values	
H = mm - in.	B = mm - in.
	Stainless steel
8 - 5/16	13 - 33/64
10 - 3/8	17.5 - 11/16
11 - 7/16	19.5 - 49/64
12.5 - 1/2	23 - 29/32
15 - 9/16	28 - 1-7/64
17.5 - 11/16	33.5 - 1-5/16
20 - 3/4	40 - 1-37/64

Schluter®-RENO-U				
Length = 2.5 m - 8' 2-1/2"	Stainless steel 304 (1.4301 = V2A) (E)		Brushed stainless steel 304 (1.4301 = V2A) (EB)	
H = mm - in.	Item No.	\$ / Length	Item No.	\$ / Length
8 - 5/16	EU 80	70.47	EBU 80	108.90
10 - 3/8	EU 100	77.08	EBU 100	115.61
11 - 7/16	EU 110	79.14	EBU 110	118.00
12.5 - 1/2	EU 125	85.53	EBU 125	124.46
15 - 9/16	EU 150	93.02	EBU 150	131.71
17.5 - 11/16	EU 175	102.35	EBU 175	140.96
20 - 3/4	EU 200	112.56	EBU 200	150.82

Schluter®-JOLLY

Schluter®-JOLLY features a 90° angle and is designed to provide edge-protection and act as a decorative edging for tile coverings. Its 90° angle creates a clean, flush look, and the joint spacers on both sides of the profile ensure consistent grout joints and perfect symmetry. Matching corners are available, which feature innovative plug-in connections that result in clean, visually appealing corner applications. JOLLY in brushed stainless steel and color-coated aluminum, as listed on this page, is suitable for use in exterior applications.



Stainless Steel

Schluter®-JOLLY				
Length = 2.5 m - 8' 2-1/2"	Brushed stainless steel 304 (1.4301 = V2A) (EB)			
H = mm - in.	Profile	\$ / Length	Outside corner	\$ / Unit
6 - 1/4	J 60 EB	56.50	EV / J 60 EB	27.19
8 - 5/16	J 80 EB	58.71	EV / J 80 EB	27.19
10 - 3/8	J 100 EB	60.30	EV / J 100 EB	27.19
11 - 7/16	J 110 EB	62.64	EV / J 110 EB	27.19
12.5 - 1/2	J 125 EB	62.88	EV / J 125 EB	27.19

Color-coated Aluminum

Schluter®-JOLLY				
Length = 2.5 m - 8' 2-1/2"	Color-coated aluminum			
H = mm - in.	Profile	\$ / Length	Outside corner	\$ / Unit
6 - 1/4	J 60 + color*	19.16	EV / J 60 + color*	12.60
8 - 5/16	J 80 + color*	20.05	EV / J 80 + color*	12.60
10 - 3/8	J 100 + color*	21.28	EV / J 100 + color*	12.60
11 - 7/16	J 110 + color*	21.96	EV / J 110 + color*	12.60
12.5 - 1/2	J 125 + color*	22.62	EV / J 125 + color*	12.60

*Color Codes



* To complete the item number, add the color code (e.g., J 80 PG).

Connector	Quantity	\$ / Pkg.
V / J PP4	4	3.65



Note: The anchoring leg of Schluter®-JOLLY is available with a special radius perforation so that the profile can be used to form curves.

- Price surcharge: \$0.70 per foot
- Color-coated aluminum profiles require a relatively large bending radius
- Item No.: R / Profile No. (e.g., R/J 80 EB)
- For delivery time, please call Customer Service





Schluter®-SCHIENE

Schluter®-SCHIENE features an 87 degree angle and is designed to provide edge-protection and act as a decorative edging for tile coverings. The integrated joint spacer creates a channel for grouting the tile. SCHIENE in color-coated aluminum, as listed on this page, is suitable for use in exterior applications and matches the color-coated aluminum BARA profiles.

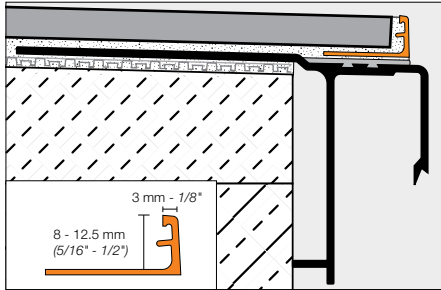

***Color Codes**

BW Bright white	HB Light beige	PG Classic grey	GM Metallic grey	RB Red brown	SB Black brown
---------------------------	--------------------------	---------------------------	----------------------------	------------------------	--------------------------

* To complete the item number, add the **color** code (e.g., A 80 **HB**).

Schluter®-SCHIENE		
Length = 2.5 m - 8' 2-1/2"	Color-coated aluminum (AC)	
H = mm - in.	Item No.	\$ / Length
8 - 5/16	A 80 + color*	19.66
10 - 3/8	A 100 + color*	20.86
12.5 - 1/2	A 125 + color*	22.18

Note: The anchoring leg of **Schluter®-SCHIENE** is available with a special radius perforation so that the profile can be used to form curves.

- Price surcharge: \$0.70 per foot
- Color-coated aluminum requires a relatively large bending radius
- Item No.: R / Profile No. (e.g., R/A 80 HB)
- For delivery time, please call Customer Service



Please be advised that SCHIENE in Color-coated Aluminum (AC) is being discontinued. These items will only remain available while supplies last. Please reference JOLLY as an alternative option.



Schluter®-RONDEC

Schluter®-RONDEC is a finishing and edge-protection profile for tiled edges and outside corners of tiled surfaces. The reveal of the profile forms a symmetrically rounded corner along the surface edge. RONDEC in stainless steel, as listed on this page, is suitable for use in exterior applications.

Sizes 60, 80, 100, and 125 are also available in stainless steel 316L (1.4404 = V4A). Contact customer service for price and availability.

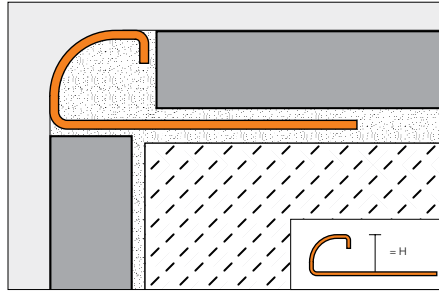

90° Outside corner (EV/)

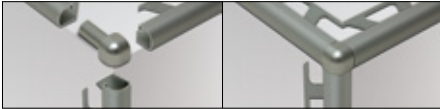

Connector Stainless Steel (V/)



End cap



Schluter®-RONDEC					
Length = 2.5 m - 8' 2-1/2"		Stainless steel 304 (1.4301 = V2A) (E)			
H = mm - in.	Profile	\$ / Length	Outside corner, 90°	\$ / Unit	
4.5 - 3/16	RO 45 E	60.49	EV/RO 45 E	44.18	
6 - 1/4	RO 60 E	61.68	EV/RO 60 E	44.09	
7 - 9/32	RO 70 E	64.17	EV/RO 70 E	45.30	
8 - 5/16	RO 80 E	64.73	EV/RO 80 E	45.30	
9 - 11/32	RO 90 E	69.13	EV/RO 90 E	48.79	
10 - 3/8	RO 100 E	69.52	EV/RO 100 E	50.86	
11 - 7/16	RO 110 E	71.90	EV/RO 110 E	52.26	
12.5 - 1/2	RO 125 E	75.00	EV/RO 125 E	52.26	
15 - 9/16	RO 150 E	85.00	EV/RO 150 E	53.93	

Length = 2.5 m - 8' 2-1/2"		Brushed stainless steel 304 (1.4301 = V2A) (EB)			
H = mm - in.	Profile	\$ / Length	Outside corner, 90°	\$ / Unit	
6 - 1/4	RO 60 EB	94.15	EV/RO 60 EB	49.51	
7 - 9/32	RO 70 EB	96.01	EV/RO 70 EB	49.51	
8 - 5/16	RO 80 EB	98.38	EV/RO 80 EB	49.51	
9 - 11/32	RO 90 EB	100.36	EV/RO 90 EB	49.51	
10 - 3/8	RO 100 EB	102.77	EV/RO 100 EB	53.88	
11 - 7/16	RO 110 EB	104.83	EV/RO 110 EB	53.88	
12.5 - 1/2	RO 125 EB	107.23	EV/RO 125 EB	53.88	
15 - 9/16	RO 150 EB	117.99	EV/RO 150 EB	56.79	

Stainless steel 304 (1.4301 = V2A) (E)		
H = mm - in.	Connector	\$ / Unit
6 - 1/4	V/RO 60 E	6.52
8 - 5/16	V/RO 80 E	6.52
10 - 3/8	V/RO 100 E	6.52
11 - 7/16	V/RO 110 E	6.52
12.5 - 1/2	V/RO 125 E	6.52

Brushed stainless steel 304 (1.4301 = V2A) (EB)		
H = mm - in.	End cap	\$ / Unit
8 - 5/16	EK/RO 80 EB	5.27
10 - 3/8	EK/RO 100 EB	5.27
12.5 - 1/2	EK/RO 125 EB	5.27



Schluter®-QUADEC

Schluter®-QUADEC is a finishing and edge-protection profile for tiled edges and outside corners of tiled surfaces. The reveal of the profile forms a square outer corner along the surface edge. QUADEC can also be used as an accent within tile fields on both floors and walls, and allows for modern decorative design and interesting contrasts. QUADEC, in stainless steel, can also be used as a stair nosing or floor transition profile, and is suitable for use in exterior applications.

Note: QUADEC is also available in stainless steel 316L (1.4404 = V4A). Contact Customer Service for pricing and availability.

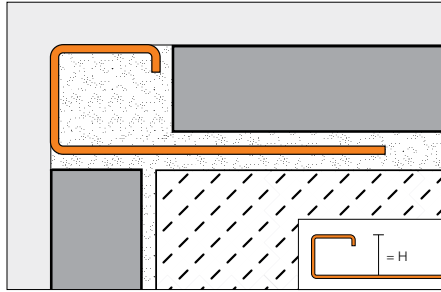

Inside/outside corner/end cap (EV/)

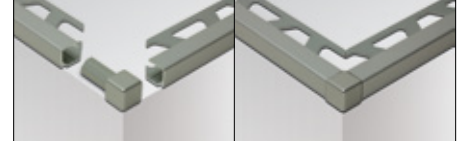
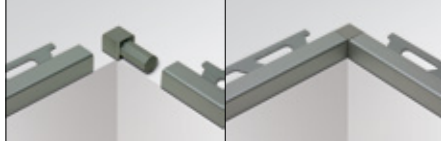

Schluter®-QUADEC						
Length = 2.5 m - 8' 2-1/2"	Stainless steel 304 (1.4301 = V2A) (E)					
H = mm - in.	Profile	\$ / Length	Inside/outside corner	\$ / Unit	Connector	\$ / Unit
4.5 - 3/16	Q 45 E	56.29	EV/Q 45 E	41.78	-	-
6 - 1/4	Q 60 E	65.98	EV/Q 60 E	47.56	V/RO 60 E	6.52
7 - 9/32	Q 70 E	68.27	EV/Q 70 E	47.56	-	-
8 - 5/16	Q 80 E	69.24	EV/Q 80 E	47.56	V/RO 80 E	6.52
9 - 11/32	Q 90 E	74.16	EV/Q 90 E	47.56	-	-
10 - 3/8	Q 100 E	74.36	EV/Q 100 E	54.88	V/RO 100 E	6.52
11 - 7/16	Q 110 E	77.95	EV/Q 110 E	54.88	V/RO 110 E	6.52
12.5 - 1/2	Q 125 E	78.76	EV/Q 125 E	54.88	V/RO 125 E	6.52
14 - 17/32	Q 140 E	82.74	EV/Q 140 E	55.97	-	-
15 - 9/16	Q 150 E	84.41	EV/Q 150 E	56.65	-	-

Length = 2.5 m - 8' 2-1/2"	Brushed stainless steel 304 (1.4301 = V2A) (EB)					
H = mm - in.	Profile	\$ / Length	Inside/outside corner	\$ / Unit	Connector	\$ / Unit
6 - 1/4	Q 60 EB	98.86	EV/Q 60 EB	51.98	V/RO 60 E	6.52
7 - 9/32	Q 70 EB	103.20	EV/Q 70 EB	51.98	-	-
8 - 5/16	Q 80 EB	106.14	EV/Q 80 EB	51.98	V/RO 80 E	6.52
9 - 11/32	Q 90 EB	108.26	EV/Q 90 EB	51.98	-	-
10 - 3/8	Q 100 EB	110.87	EV/Q 100 EB	56.58	V/RO 100 E	6.52
11 - 7/16	Q 110 EB	113.32	EV/Q 110 EB	56.58	V/RO 110 E	6.52
12.5 - 1/2	Q 125 EB	115.70	EV/Q 125 EB	56.58	V/RO 125 E	6.52
14 - 17/32	Q 140 EB	118.04	EV/Q 140 EB	57.71	-	-
15 - 9/16	Q 150 EB	120.39	EV/Q 150 EB	59.36	-	-



Schluter®-SCHIENE-STEP

Schluter®-SCHIENE-STEP is a finishing and edging profile for ceramic tile and natural stone installations on countertops, stairs, and tile over tile applications on walls. The top of the profile features a vertical wall section that finishes and protects the tile from damage, while the vertical leg covers the edge of the sub-assembly, top of the riser, or existing wall tile edge.

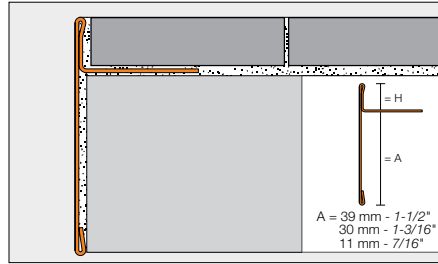

SCHIENE-STEP is available in three vertical leg lengths: 1-1/2" (39 mm), 1-3/16" (30 mm), and 7/16" (11 mm).

Schluter®-SCHIENE-STEP								
Length = 2.5 m - 8' 2-1/2"		Brushed Stainless Steel 304 (1.4301 = V2A) (EB)						
H = mm - in.	Profile	\$/ Length	Inside corner, 90°	Inside corner, 135°	Outside corner, 90° and End Cap	Outside corner, 135°	\$/ Unit	
A: 39 mm - 1-1/2"								
6 - 1/4	SS 60 EB 39	165.59	I90 / SS 60 EB 39	I135 / SS 60 EB 39	E90 / SS 60 EB 39	E135 / SS 60 EB 39	22.22	
9 - 11/32	SS 90 EB 39	172.44	I90 / SS 90 EB 39	I135 / SS 90 EB 39	E90 / SS 90 EB 39	E135 / SS 90 EB 39	22.22	
11 - 7/16	SS 110 EB 39	174.49	I90 / SS 110 EB 39	I135 / SS 110 EB 39	E90 / SS 110 EB 39	E135 / SS 110 EB 39	22.22	
12.5 - 1/2	SS 125 EB 39	178.31	I90 / SS 125 EB 39	I135 / SS 125 EB 39	E90 / SS 125 EB 39	E135 / SS 125 EB 39	22.22	
A: 30 mm - 1-3/16"								
9 - 11/32	SS 90 EB 30	129.01	-	-	E90 / SS 90 EB 30	-	22.22	
11 - 7/16	SS 110 EB 30	130.58	-	-	E90 / SS 110 EB 30	-	22.22	
12.5 - 1/2	SS 125 EB 30	132.16	-	-	E90 / SS 125 EB 30	-	22.22	
A: 11 mm - 7/16"								
6 - 1/4	SS 60 EB 11	126.61						
12.5 - 1/2	SS 125 EB 11	128.11						

Brushed Stainless Steel 304 (1.4301 = V2A) (EB)		
H = mm - in.	Connector	\$/ Unit
A: 39 mm - 1-1/2"		
6 - 1/4	V / SS 60 EB 39	18.87
9 - 11/32	V / SS 90 EB 39	18.87
11 - 7/16	V / SS 110 EB 39	18.87
12.5 - 1/2	V / SS 125 EB 39	18.87
A: 30 mm - 1-3/16"		
9 - 11/32	V / SS 90 EB 30	18.87
11 - 7/16	V / SS 110 EB 30	18.87
12.5 - 1/2	V / SS 125 EB 30	18.87
A: 11 mm - 7/16"		
6 - 1/4	V / SS 60 EB 11	18.87
12.5 - 1/2	V / SS 125 EB 11	18.87

Note: The anchoring leg of **Schluter®-SCHIENE-STEP** is available with a special radius perforation so that the profile can be used to form curves.

- Price surcharge: \$0.70 per foot
- Item No.: R / Profile No. (e.g., R/SS 60 EB 11)
- For delivery time, please call Customer Service





Schluter®-TREP-FL

Schluter®-TREP-FL is a decorative stair-nosing profile with a protruding rounded edge that can be integrated into stairs covered with tile or stone. The profile protects the front edge of stairs and adds a high degree of safety by improving the visibility of the stair edges. TREP-FL is suitable for interior and exterior residential applications, e.g., stairs not exposed to heavy traffic.

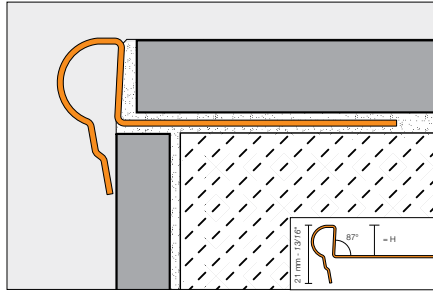

End cap (E/)

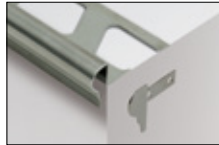

Schluter®-TREP-FL		
Stainless steel 304 (1.4301 = V2A) (E)		
H = mm - in.	Item No.	\$ / Length
L = 2.5 m - 8' 2-1/2"		
9 - 11/32	FL 90 E	76.65
11 - 7/16	FL 110 E	80.00
12.5 - 1/2	FL 125 E	83.55
L = 1.50 m - 4' 11"		
9 - 11/32	FL 90 E/150	46.00
11 - 7/16	FL 110 E/150	48.00
12.5 - 1/2	FL 125 E/150	50.14
End cap		\$ / Unit
E/FLEB		5.47

Schluter®-TREP-FL		
Brushed stainless steel 304 (1.4301 = V2A) (EB)		
H = mm - in.	Item No.	\$ / Length
L = 2.5 m - 8' 2-1/2"		
9 - 11/32	FL 90 EB	91.98
11 - 7/16	FL 110 EB	95.98
12.5 - 1/2	FL 125 EB	100.26
L = 1.50 m - 4' 11"		
9 - 11/32	FL 90 EB/150	55.19
11 - 7/16	FL 110 EB/150	57.59
12.5 - 1/2	FL 125 EB/150	60.17
End cap		\$ / Unit
E/FLEB		5.47

Schluter®-TREP-E

Schluter®-TREP-E is designed to protect tiled stair edges and provide an easily visible, slip-resistant wear surface for durable, safe, and visually appealing stair-nosing design. The profile is made of stainless steel with an integrated non-slip tread, making it suitable for interior and exterior use in areas subjected to heavy foot-traffic, such as offices or public buildings. TREP-E features a trapezoid-perforated anchoring leg that is secured in the bond coat beneath the tile.

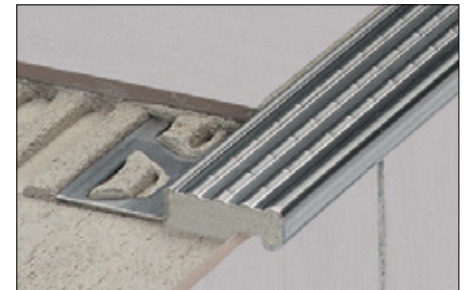
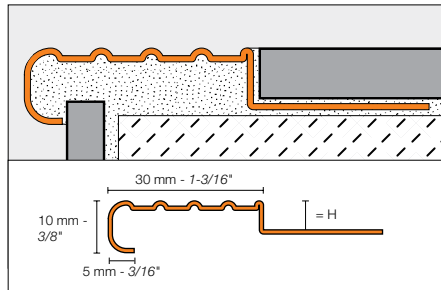

Note: Sizes 80, 110, and 160 are also available in stainless steel 316L (1.4404 = V4A). Contact Customer Service for pricing and availability.



A version without the anchoring leg for retrofit applications is also available. Please refer to TREP-EK on page 32.

Schluter®-TREP-E		
Stainless steel 304 (1.4301 = V2A) (E)		
H = mm - in.	Item No.	\$ / Length
L = 2.5 m - 8' 2-1/2"		
2 - 3/32	TE 20	62.09
5 - 3/16	TE 50	64.21
8 - 5/16	TE 80	66.21
11 - 7/16	TE 110	68.07
16 - 5/8	TE 160	71.43
25 - 1	TE 250	77.55
L = 1.50 m - 4' 11"		
2 - 3/32	TE 20/150	38.79
5 - 3/16	TE 50/150	40.14
8 - 5/16	TE 80/150	41.37
11 - 7/16	TE 110/150	42.53
16 - 5/8	TE 160/150	44.67
25 - 1	TE 250/150	48.46
End cap		\$ / Unit
E/TE		3.64

End cap (E/)





Safety can be retrofitted

The installation of stair nosing profiles is not always a consideration during the initial construction of stairs. Schluter®-TREP profiles are also available for retrofit installation to help you enhance the safety of stairs at a later point. Schluter®-KERDI-FIX or other suitable adhesive/sealant ensures the secure installation of these profiles:

- Schluter®-TREP-EK with slip-resistant wear surface
- Schluter®-TREP-EFK for bonding in milled grooves



Schluter®-TREP-EK

Schluter®-TREP-EK is designed to protect tiled stair edges and provide an easily visible, slip-resistant wear surface for durable, safe, and visually appealing stair-nosing design. The profile is made of stainless steel with an integrated non-slip tread, making it suitable for interior and exterior use in areas subjected to heavy foot-traffic, such as offices or public buildings.

TREP-EK is subsequently bonded to existing installations. As such, TREP-EK can be installed as a repair so that existing, damaged stair treads do not have to be replaced.

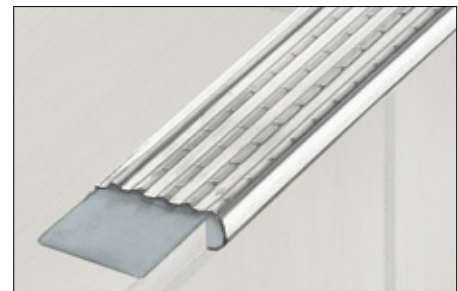
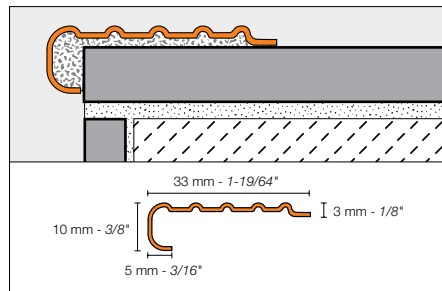

Schluter®-TREP-EK	
Stainless steel 304 (1.4301 = V2A) (E)	
Item No.	\$ / Length
L = 2.5 m - 8' 2-1/2"	
TEK	52.49
L = 1.50 m - 4' 11"	
TEK/150	31.50

Schluter®-TREP-EFK

Schluter®-TREP-EFK is a retrofit stainless steel stair profile which is bonded to existing steps. The stair profile features an easily visible, slip-resistant wear surface for durable and safe stairs. The profile is suitable for interior and exterior use in areas subjected to heavy foot traffic, such as offices or public buildings.

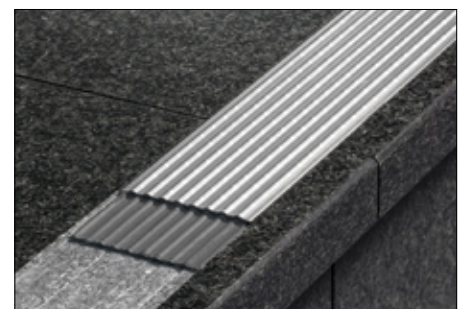
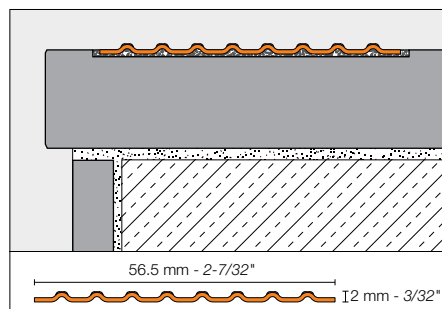

Schluter®-TREP-EFK	
Stainless steel 316L (1.4404 = V4A) (E)	
Item No.	\$ / Length
L = 2.5 m - 8' 2-1/2"	
TEF56K/V4A	88.54



Schluter®-DILEX-EDP

Schluter®-DILEX-EDP is a stainless steel surface joint profile that protects tile edges and separates individual fields in the tile covering. The profile accommodates horizontal movement via the 15/32" (12 mm)-wide stainless steel tongue-and-groove connection, which also forms the visible surface. DILEX-EDP is particularly suited for tile surfaces subject to heavy use, including areas exposed to continuous vehicular traffic in interior and exterior applications.

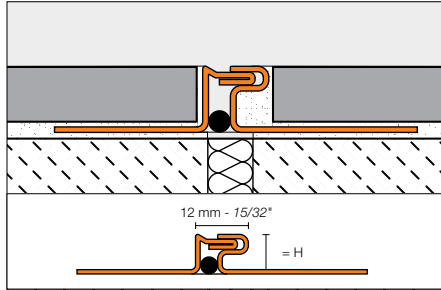

Schluter®-DILEX-EDP			
Length = 2.5 m - 8' 2-1/2"		Stainless steel 304 (1.4301 = V2A) (E)	
H = mm - in.		Item No.	\$ / Length
10 - 3/8		EDP 100	141.67
11 - 7/16		EDP 110	142.97
12.5 - 1/2		EDP 125	145.41
16 - 5/8		EDP 160	150.86
21 - 13/16		EDP 210	157.97



Schluter®-DILEX-KSN

Schluter®-DILEX-KSN is a surface joint profile with stainless steel anchoring legs that protect tile edges and a 7/16" (11 mm)-wide, soft thermoplastic rubber movement zone that separates individual fields in the tile covering and forms the visible surface. The movement zone is available in different colors to match the grout and can be replaced if damaged. DILEX-KSN in stainless steel offers secure edge protection for surfaces exposed to heavy-duty commercial traffic in interior and exterior applications.

Note: DILEX-KSN is also available in stainless steel 316L (1.4404 = V4A). Contact Customer Service for price and availability.

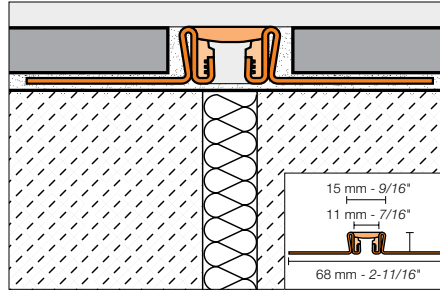

***Color Codes**

SP Sand pebble	HB Light beige	PG Classic grey	G Grey	C ¹ Cream
SG ¹ Stone Grey	FG ¹ Grout Grey	DA ¹ Dark Anthracite	GS Black	

* To complete the item number, add the **color** code (e.g., EKSX 125 **G**).

¹ The colors cream (C), stone grey (SG), grout grey (FG), and dark anthracite (DA) are only available in the following profile sizes: 100, 110, 125, 140, and 160

Schluter®-DILEX-KSN			
Length = 2.5 m - 8' 2-1/2"		Stainless steel 304 (1.4301 = V2A) (E)	
H = mm - in.		Item No.	\$ / Length
8 - 5/16		EKSX 80 + color*	126.55
10 - 3/8		EKSX 100 + color*	151.25
11 - 7/16		EKSX 110 + color*	152.77
12.5 - 1/2		EKSX 125 + color*	155.77
14 - 17/32		EKSX 140 + color*	158.50
16 - 5/8		EKSX 160 + color*	163.01
18.5 - 23/32		EKSX 185 + color*	166.64
21 - 13/16		EKSX 210 + color*	171.17
25 - 1		EKSX 250 + color*	179.32
30 - 1-3/16		EKSX 300 + color*	187.47
Rubber insert replacement		KSE/ + color*	20.34

Schluter®-DILEX-KSA

Schluter®-DILEX-KSA is a perimeter joint profile with a stainless steel anchoring leg and a 3/8" (10 mm)-wide, soft thermoplastic rubber movement zone that isolates the tile covering from fixed building elements (e.g., window and door frames). The movement zone is available in different colors to match the grout and can be replaced if damaged. The profile also features a self-adhesive strip that allows it to bond to the fixed building elements. The DILEX-KSA with stainless steel anchoring leg, as listed on this page, is suitable for use in exterior applications.

Note: DILEX-KSA is also available in stainless steel 316L (1.4404 = V4A). Contact Customer Service for price and availability.

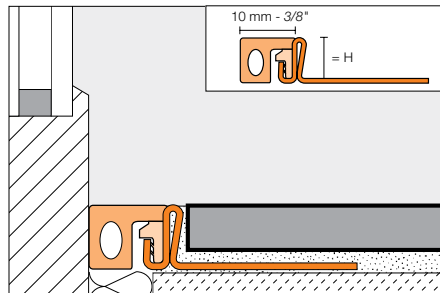

***Color Codes**

HB Light beige	PG Classic grey	G Grey	GS Black
-------------------	--------------------	-----------	-------------

* To complete the item number, add the **color** code (e.g., EKSA 80 **G**).

Schluter®-DILEX-KSA			
Length = 2.5 m - 8' 2-1/2"		Stainless steel 304 (1.4301 = V2A) (E)	
H = mm - in.		Item No.	\$ / Length
8 - 5/16		EKSA 80 + color*	79.71
10 - 3/8		EKSA 100 + color*	97.14
11 - 7/16		EKSA 110 + color*	98.12
12.5 - 1/2		EKSA 125 + color*	100.09
14 - 17/32		EKSA 140 + color*	101.80
16 - 5/8		EKSA 160 + color*	104.72
18.5 - 23/32		EKSA 185 + color*	107.06
21 - 13/16		EKSA 210 + color*	109.95
25 - 1		EKSA 250 + color*	115.21
30 - 1-3/16		EKSA 300 + color*	120.45
Rubber insert replacement		KSAE/+ color*	20.51



SETTING MATERIALS

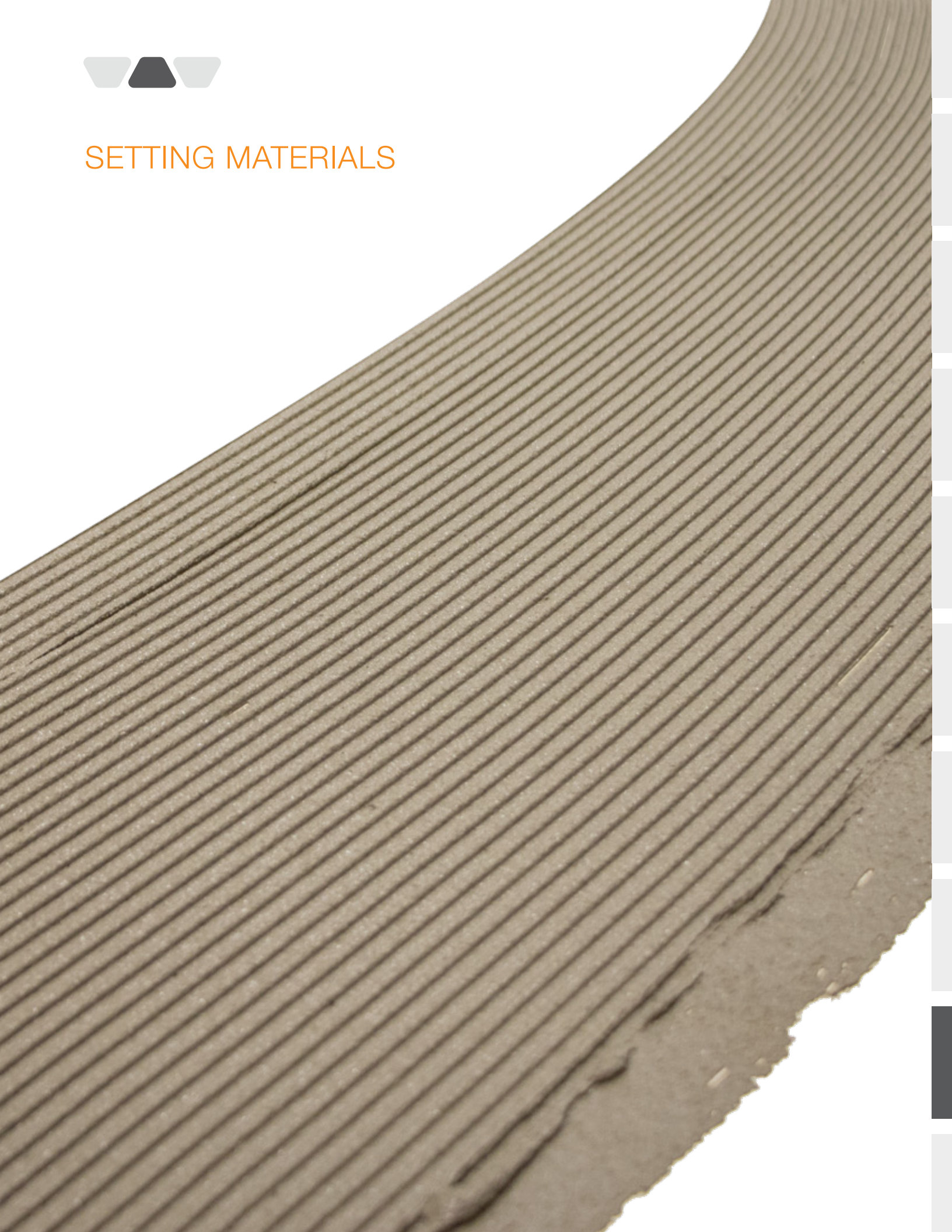

Schluter®-SET

Schluter®-SET is a premium unmodified thin-set mortar specifically formulated for use with Schluter® membranes and boards. It is sag-resistant, smooth and creamy, and easy to handle and spread. Schluter®-SET is suitable for use with ceramic, porcelain, and stone tile, including large and heavy tile, in conjunction with Schluter®-Systems' membranes (e.g., DITRA-DRAIN), the Schluter®-Shower System, and Schluter®-KERDI-BOARD.



Schluter®-SET meets the requirements of ANSI A118.1, and is available in both grey and white.

Schluter®-SET			
Premium unmodified mortar			
Item No.	Color	Weight	\$ / Unit
SET50G	Grey	22.7 kg - 50 lbs	31.42
SET50W	White	22.7 kg - 50 lbs	34.04

Schluter®-ALL-SET

Schluter®-ALL-SET is a specialized modified thin-set mortar specifically formulated for use with Schluter® membranes and boards. It is engineered for use both under and over all DITRA and KERDI products. It is sag-resistant, smooth and creamy, and easy to handle and spread. ALL-SET is suitable for use with ceramic, porcelain, and stone tile, including large and heavy tile, in conjunction with Schluter®-Systems' membranes (e.g., DITRA-DRAIN), the Schluter®-Shower System, and Schluter®-KERDI-BOARD.



ALL-SET meets the requirements of ANSI A118.4, A118.11, and A118.15, and is available in both grey and white.

Schluter®-ALL-SET			
Specialized modified mortar			
Item No.	Color	Weight	\$ / Unit
SETA50G	Grey	22.7 kg - 50 lbs	56.09
SETA50W	White	22.7 kg - 50 lbs	59.40

Schluter®-FAST-SET

Schluter®-FAST-SET is a specialized rapid-setting modified thin-set mortar specifically formulated for use with Schluter® membranes and boards. It is engineered for use both under and over all DITRA and KERDI products. FAST-SET is ready to grout in 4 hours for fast-track projects. It is sag-resistant, smooth and creamy, and easy to handle and spread. FAST-SET is suitable for use with ceramic, porcelain, and stone tile, including large and heavy tile, in conjunction with Schluter®-Systems' membranes (e.g., DITRA-DRAIN), the Schluter®-Shower System, and Schluter®-KERDI-BOARD.



FAST-SET meets the requirements of ANSI A118.4TF, A118.11, and A118.15TF, and is available in both grey and white.

Schluter®-FAST-SET			
Specialized rapid-setting mortar			
Item No.	Color	Weight	\$ / Unit
SETF50G	Grey	22.7 kg - 50 lbs	105.32
SETF50W	White	22.7 kg - 50 lbs	115.47



Quantity per pallet is 56 bags. Minimum order is 4 pallets.
 Special freight conditions apply, please see Conditions of Sale on pages 38-40 for details.
 Bundle offers for thin-set pallets with other products (i.e. DITRA and KERDI) are available, and are eligible for free shipping.
 Please consult a Schluter Sales Representative for more details.

Schluter®-PROCUT-TSM

Schluter®-PROCUT-TSM is a cutting wheel with a diameter of 4-1/2" (115 mm) for conventional angle grinders. It produces especially clean cuts of stainless steel, aluminum, and brass profiles.

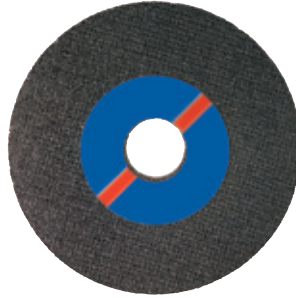

Schluter®-PROCUT-TSM	
Item No.	\$ / Unit
TSM 115/1	17.58

Schluter®-TROWEL

The **DITRA-HEAT/-DITRA-XL-TROWEL** features a 1/4" x 1/4" (6 mm x 6 mm) square-notched design to effectively install DITRA-DRAIN.

The trowel is made of uncoated stainless steel, making it even more durable.



Schluter®-TROWEL		
Item No.	Notch Size	\$ / Unit
DITRA-HEAT/-DITRA-XL		
TRL-DHXL	6 mm x 6 mm - 1/4" x 1/4"	37.92

Schluter®-DITRA-ROLLER

Schluter®-DITRA-ROLLER is used to embed DITRA membranes, including DITRA-DRAIN, in the bond coat during membrane installation. The lightweight DITRA-ROLLER features a 14-1/2" (37 cm) wide roller and a shelf for placing 50 to 75 lbs of weight (e.g., bag of thin-set mortar or grout, box of tiles, etc.). Between uses, it can be conveniently disassembled for transport and storage.



Schluter®-DITRA-ROLLER	
Item No.	\$ / Unit
DIRO	296.19

CONDITIONS OF SALE

1. Terms and Conditions

These terms and conditions of sale (hereinafter referred to as the "Terms") govern the sale of Products from Schluter Systems (Canada) Inc. ("Schluter") to Customer where such products are to be used within Canada. "Products" is defined to mean the products identified on the order confirmation or invoice, whichever is issued later by Schluter to Customer; and "Customer" is defined to mean the purchasing entity identified on such documents. The Terms herein, the terms and conditions contained on any order confirmation and/or invoice, and the terms and conditions contained in any applicable Credit Application, and/or supply agreement between Schluter and Customer, if any, represent the final and complete agreement of Schluter and Customer as to the sale and purchase of Products (the "Agreement"). In the event of any conflicting terms or conditions in the Agreement, the supply agreement, if any, shall be deemed to control; in the absence of a supply agreement, the order confirmation shall be deemed to control. Any and all different or additional terms than those contained in the Agreement are rejected unless expressly accepted in writing by an authorized representative of Schluter.

2. Price and Payment

Payment terms are net thirty (30) days from invoice date. No payments shall be subject to any setoffs, deductions or claims. For any amounts not paid by Customer as of the due date, Customer shall be liable to pay interest on the amount due at a rate of 1.5% per month from due date until date of payment in addition to the principal amount. Regardless of any statement appearing on a check or otherwise, Schluter's acceptance of a payment in an amount less than that due shall in no way be an accord and satisfaction or prejudice Schluter's rights and remedies to collect the full amount due. Prices do not include sales taxes or other charges levied by any governmental authority upon the sale, use or transportation of the Products, all of which shall be paid by Customer, including, without limitation, applicable customs duties and tariffs. Prices quoted in the Price List Catalog are subject to change without prior notice.

For the most current version of the Price List, please visit www.schluter.ca.

3. Shipping/Title/Risk of Loss

Unless otherwise expressly set forth in writing by Schluter, all Products will be delivered Ex Works (as defined in Incoterms 2017 revision). Dates of shipments are estimated and not guaranteed. Title and risk of loss to Products shall transfer to Customer upon delivery in accordance with the applicable delivery terms. Any handling of the Products after transfer of risk of loss shall be at Customer's sole risk.

4. Freight and Shipping Charges

Prices quoted in the Price List Catalog include ground freight charges within Canada, save and except for purchase orders under \$10,000 gross at retail, to which freight charges according to the table below will be added thereto.

Ground Freight Charges				
Orders up to \$500	\$500 to \$1,500	\$1,500 to \$3,000	\$3,000 to \$5,000	\$5,000 to \$10,000
\$125	\$200	\$250	\$300	\$375

Schluter offers air express shipping to Canada; please see table below for options and pricing. Please allow 1 to 3 business days for delivery on air express shipping.

Air Express orders to Northwest Territories: please contact Customer Service for eligibility.

Air Express Handling Freight Charges				
Gross order value at retail	up to \$500	\$500 to \$1,500	\$1,500 to \$3,000	\$3,000 to \$5,000
Charge	\$200	\$250	\$325	\$450

Air express orders greater than \$5,000 gross at retail are charged actual freight.

Certain items with oversized shipping dimensions are not eligible for air express shipping. **Additionally, certain items (such as 10' profiles) are not eligible for parcel shipping and are subject to an additional \$375 ground freight charge unless combined with an order exceeding \$10,000 gross at retail.**

Freight charges including air express handling charges are subject to change without prior notice. Please note that we are unable to accommodate third party transport billing.

Accessories include corners and caps for profiles and Rema kits up to \$500 gross at retail:

Regular ground handling	Air express handling
\$70	\$100

Accessory orders over \$500 gross at retail are subject to standard shipping charges.

KERDI-BOARD panels:

- 1 to 5 full pallets: \$150/pallet
- 6+ full pallets: free shipping

THIN-SET pallets: minimum order equals 4 full pallets (1 pallet equals 56 bags per item number)

- 4 to 14 full pallets: \$500 freight charge per order
- 15 pallets: free shipping

Bundle offers for thin-set pallets with other products (i.e. DITRA and KERDI) are available and are eligible for free shipping. Please consult with a Schluter Sales Representative for more details.

3rd party shipping (drop shipping):

- Orders to a third party will incur a 10% handling fee.
- THIN-SET only orders to a third party will incur a \$200 handling fee.

5. Product Inspection; Non-conformity

Customer must inspect the Products upon delivery and notify Schluter in writing of any physical damage to the Products or nonconformity with the purchase order or invoice. **FAILURE TO INSPECT AND DELIVER WRITTEN NOTICE OF SUCH DAMAGE OR NONCONFORMITY WITHIN SUCH FORTY EIGHT (48) HOUR PERIOD SHALL CONSTITUTE IRREVOCABLE ACCEPTANCE OF THE DELIVERED PRODUCTS AND A WAIVER OF ANY DAMAGE OR NONCONFORMITY THAT WAS OR SHOULD HAVE BEEN DETECTED.** Any use of the Products or any portion thereof shall constitute irrevocable acceptance of such Products. As Customer's sole remedy for any damaged or nonconforming Products of which Customer has delivered to Schluter timely notice of damaged or nonconforming Products, Schluter, at Schluter's sole election, shall either: (a) replace the damaged or nonconforming Products, or (b) refund the price paid by Customer to Schluter for such damaged or nonconforming Products. In no event shall Schluter be liable for costs of procurement or substitute Products by Customer, or for injury or damage to business, or loss of profits, nor shall Schluter be liable for any incidental, special, indirect, or consequential damages. Any Product images are for illustrative purposes only; any differences between Product images and actual Product received shall not constitute nonconforming Product.

6. Cancellations

If Customer fails to make payment in accordance, or otherwise comply, with all terms of the Agreement, Schluter may, at its option (and in addition to all other remedies), cancel any unshipped portion of Customer's order, without liability to Schluter, and Customer shall remain liable for all unpaid amounts. Subject only to Section 5 herein, orders, once accepted by Schluter, cannot be cancelled without Schluter's prior written consent, which may be granted or withheld in Schluter's sole and absolute discretion. In no event shall Schluter authorize the cancellation or deferment of shipment unless Schluter is indemnified against the loss resulting therefrom. Orders issued a tracking number are considered shipped; any cancellation or deferment will incur a 25% restocking fee.

7. Returns

Schluter shall not accept any returns unless it specifically authorizes such in writing, which may be granted or withheld in Schluter's sole and absolute discretion. Under no circumstances shall Schluter accept any returned Products after thirty (30) days from such Products' invoice date. Any authorized returns must be in resellable condition subject to inspection by Schluter prior to acceptance of same. All authorized returns shall incur a handling charge of 25%.

8. Special Orders

Customer will defend, at its own expense, any suit which may be brought against Schluter by reason of the manufacture or sale of special or non-stock Products made to Customer's specifications, including any third party proceedings. In the case of cancellation of orders of special or non-stock Products, Customer's cancellation may be conditioned upon Customer's payment in full of the price of finished Products. Schluter shall not accept any returns of special or non-stock Products.

9. Warranty and Damages Disclaimer

a. Warranty The Products are covered by product-specific warranties, available at www.schluter.ca or Schluter's Warranties Page. The warranty that applies is the applicable warranty in effect for the Products as of the date of the proforma invoice, or if no proforma invoice, as of the date of the order acknowledgement for the Products (the "Written Warranty").

b. Disclaimer THE WRITTEN WARRANTY IS THE ONLY WARRANTY APPLICABLE TO THE PRODUCTS AND EXCLUDES ALL OTHER WARRANTIES, INCLUDING, WITHOUT LIMITATION, ANY IMPLIED WARRANTY OF MERCHANTABILITY OR FITNESS FOR A PARTICULAR PURPOSE, AND ANY IMPLIED WARRANTIES OTHERWISE ARISING FROM A COURSE OF DEALING OR USAGE OF TRADE, EXCEPT WHERE PURCHASE OF THE PRODUCTS IS SUBJECT TO CONSUMER PRODUCT WARRANTY LAWS, IN WHICH INSTANCES ANY APPLICABLE IMPLIED WARRANTIES ARE LIMITED TO THE PERIOD OF THE APPLICABLE WRITTEN WARRANTY, OR SUCH SHORTER PERIOD AS PERMITTED OR REQUIRED UNDER APPLICABLE LAW. IN NO EVENT WILL SCHLUTER BE LIABLE FOR ANY INCIDENTAL, SPECIAL, INDIRECT, OR CONSEQUENTIAL DAMAGES, HOWEVER CAUSED, WHETHER FOR BREACH OF CONTRACT, BREACH OF WARRANTY, TERMINATION, NEGLIGENCE, OR OTHERWISE, EVEN IF SCHLUTER SHALL HAVE BEEN ADVISED OF THE POSSIBILITY OF SUCH DAMAGES. Recommendations, advice, representations, warranties, commitments or agreements that are inconsistent with the foregoing disclaimer shall not be binding on Schluter unless in a writing signed by an authorized representative of Schluter. Schluter's only obligation is to provide the Products in the quantities ordered by Customer (which order is accepted by Schluter) without regard to the Products' appropriateness to Customer's application. Customer represents and warrants that Customer is not a "consumer" as defined by any applicable usury or consumer protection laws.

10. Delay/Force Majeure

Delay in delivery or nondelivery by Schluter shall not be a breach or default by Schluter if performance is delayed or made impracticable or impossible by the occurrence of any one or more of the following: (a) fire, flood, or other casualty, (b) war, riot, embargo, governmental regulation or martial law, (c) inability to obtain necessary materials from usual sources of supply, (d) shortage of transportation or delays in transit, (e) strike or other labor issue, and (f) other conditions not reasonably within Schluter's control, whether or not of a kind mentioned herein.

11. Choice of Law

For sales made in Canada or its territories, the Agreement (including, without limitation, these Terms) shall be governed by the Province of Quebec, without regard for its choice of law provisions.

12. Arbitration

a. Any controversy, claim or dispute arising out of or in connection with the Agreement shall be settled by final and binding arbitration administered by the Canadian Arbitration Association in accordance with its Arbitration Rules in the judicial district of Montreal, province of Quebec and judgment on the award rendered by the arbitrator may be entered in any court having jurisdiction. The arbitration shall be heard by a single arbitrator appointed in accordance with the Arbitration Rules, and shall be conducted in English.

b. If a controversy or claim relates to or is the subject of a mechanic's or construction lien, Schluter may proceed in accordance with applicable law to preserve and enforce its lien rights. TO THE FULLEST EXTENT PERMITTED BY LAW, NOTWITHSTANDING ANY ARBITRATION RULE OR PROCEDURE, (A) NO CONTROVERSY OR CLAIM ARISING OUT OF OR RELATING TO THE AGREEMENT SHALL BE CONSOLIDATED OR JOINED WITH ANY OTHER PERSON'S CLAIM AND NO CLASS ACTION OR REPRESENTATIVE ACTIONS SHALL BE PERMITTED UNDER THE AGREEMENT, AND (B) IF ANY CLASS OR REPRESENTATIVE ACTION CANNOT BE WAIVED UNDER APPLICABLE LAW, THE PARTIES AGREE THAT SUCH ACTION SHALL BE ARBITRATED.

13. Miscellaneous

No amendment, alteration, variation, deletion, addition, and/or cancellation of these Terms made by Customer shall be of any force or effect unless reduced to writing and signed by a director of Schluter. If any clause, subclause, or other provision of these Terms is invalid under any statute or rule of law, such provision, to that extent only, shall be deemed to be omitted without affecting the validity of the remainder of the Terms. Customer shall pay to Schluter all costs of collection, including, without limitation, reasonable attorneys' fees, incurred by Schluter in enforcing the Agreement, including, without limitation, collecting any money due from Customer and enforcing Schluter's lien rights. No waiver by Schluter of any term or any obligation of Customer shall constitute a waiver of any other term or obligation. Customer shall not assign or transfer its rights or obligations under the Agreement without the prior written consent of Schluter. All of Customer's representations, warranties and indemnities under the Agreement shall survive the consummation of or the termination or cancellation of any purchase and sale of Products. Which party prepared the Agreement shall have no bearing on the construction or interpretation of the Agreement. Buyer will defend, at its own expense, any suit or legal proceeding, including any third party proceedings, which may be brought against Schluter by reason of the manufacture or sale of any special product(s) made to Buyer's specifications. These Terms supersede all prior versions of Schluter's Conditions of Sale. Schluter reserves the right in its sole discretion to amend these Terms from time to time and any such amended terms and conditions shall be binding on Customer. For the most current version of the Terms, please visit schluter.ca/terms.

Copyright Notice

The Schluter-Systems Illustrated Price List is protected by copyright laws. Its entire content, including images and text, may not be reproduced, distributed, modified, reused, or otherwise used without the express written permission of Schluter-Systems.

© 2025 Schluter-Systems. All rights reserved.

Trademark Notice

All product names, logos and/or designs, including but not limited to those listed on our website, schluter.ca/trademarks, are owned by Schluter-Systems. It may not be a complete list of trademarks owned by Schluter-Systems as it does not list all common law trademarks and trademark applications or registrations worldwide. The unauthorized use or misuse of these trademarks is expressly prohibited and may be in violation of intellectual property rights which shall be enforced.

