

SHOWER SYSTEM



INNOVATIVE SOLUTIONS FOR CERAMIC AND STONE TILE

INTEGRATED BONDED WATERPROOFING SYSTEM FOR TILED SHOWERS

The Schluter®-Shower System is an integrated family of products that together form a fully bonded, watertight assembly for tiled showers. Unlike shower pan liners in conventional assemblies, bonded waterproof membranes, such as Schluter®-KERDI, bond directly to the mortar bed and protect it from becoming saturated with regular use. In addition, the KERDI membrane or Schluter®-KERDI-BOARD waterproof building panel protect wall cavities from vapor penetration. The Schluter®-KERDI-DRAIN and Schluter®-KERDI-LINE floor drains provide a simple and secure connection to the KERDI membrane at the top of the assembly. Other components include the Schluter®-KERDI-SEAL-PS/-MV prefabricated seals and the Schluter®-KERDI-FIX adhesive/sealant, used to treat protrusions through the membrane, and the Schluter®-KERDI-SHOWER prefabricated substrates, which can reduce weight and installation time. The integrated Schluter®-Shower System eliminates leaks, reduces the potential for efflorescence and mold growth in the system, and dramatically reduces total installation time to ensure success and make shower installation easier than ever.



8.1 Schluter®-KERDI

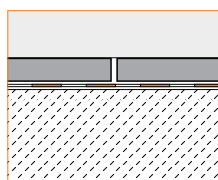

12.1 Schluter®-KERDI-BOARD

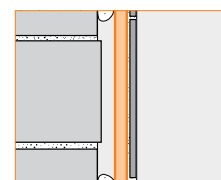

8.2 Schluter®-KERDI-DRAIN
8.7 Schluter®-KERDI-LINE



8.3 Schluter®-KERDI-SHOWER-ST
8.8 Schluter®-KERDI-SHOWER-L/-LS

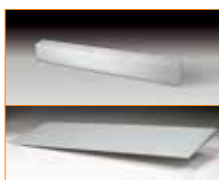

8.3 Schluter®-KERDI-SHOWER
-SC/-SR/-SB

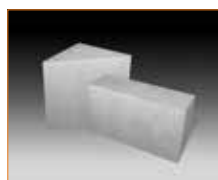

12.1 Schluter®-KERDI-BOARD-SN



8.1 Schluter®-KERDI-BAND/
-KERECK/-KERS

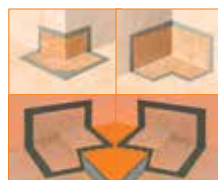

8.1 Schluter®-KERDI-SEAL-PS/-MV



14.1 Schluter®-SHOWERPROFILE-S/-R



14.1 Schluter®-SHOWERPROFILE
-W/-WSK





Prefabricated Shower Substrates

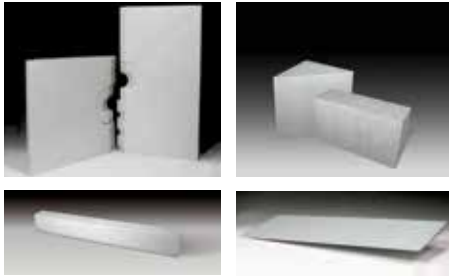

8.3 Schluter®-KERDI-SHOWER-ST/-SC/-SR/-SB

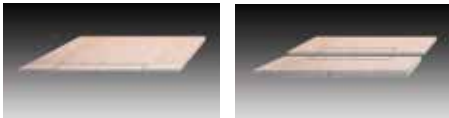

8.8 Schluter®-KERDI-SHOWER-L/-LS



12.1 Schluter®-KERDI-BOARD-SN

Schluter® prefabricated shower substrates provide an alternative to shower bases constructed of mortar and other shower elements constructed of framing and solid backing. The shower tray, curb, ramp, bench, and niche are especially useful in large-scale, repetitive jobs, such as hotels, apartments, and condominiums for the significant time savings that can be realized.

Application and Function

8.3 Schluter®-KERDI-SHOWER-ST/-SC/-SR/-SB are prefabricated substrates, made of expanded polystyrene foam, for use in conjunction with the KERDI waterproofing membrane. The KERDI-SHOWER-ST sloped shower tray is specifically designed to accept the KERDI-DRAIN and is available in 48" x 48" (122 x 122 cm), 32" x 60" (81 x 152 cm), and 72" x 72" (183 x 183 cm) sizes. KERDI-SHOWER-SC is a prefabricated curb that can be used in conjunction with any shower base. Curb dimensions are 48" x 6" x 4-1/2" (122 x 15 x 11.5 cm). KERDI-SHOWER-SR is a ramp designed to facilitate the construction of access ramps for tiled showers. Ramp dimensions are 48" x 15-7/8" x 1-1/2" (122 x 40 x 3.8 cm). The KERDI-SHOWER-SB shower bench is available in triangular and rectangular

8.3 Schluter®-KERDI-SHOWER-ST/-SC/-SR

Property	Method	Value
Density	ASTM D3575	2.75 lb/ft ³ (44 Kg/m ³)
Compressive Strength ¹	ASTM D3575 & D1621	48 psi (331 kPa)
Linear Expansion	ASTM D696	3.5 x 10 ⁻⁵ /°F
Maximum Service Temperature	-	175 °F (79 °C)

¹ Compressive strength measured at 10% deflection of foam

configurations in the following sizes (width x depth x height). The triangular bench is 16" x 16" x 20" (41 x 41 x 51 cm). The rectangular benches are 32" x 11-1/2" x 20" (81 x 29 x 51 cm), 42" x 11-1/2" x 20" (107 x 29 x 51 cm), 48" x 11-1/2" x 20" (122 x 29 x 51 cm), 32" x 16" x 20" (81 x 41 x 51 cm) and 48" x 16" x 20" (122 x 41 x 51 cm).

8.8 Schluter®-KERDI-SHOWER-L/-LS

are prefabricated expanded polystyrene sloped trays with integrated KERDI waterproofing specifically designed to accept the KERDI-LINE linear drain. The trays are available for wall (-LS) or center (-L) drain placement and are available in 39" x 39" (100 x 100 cm) and 55" x 55" (140 x 140 cm) sizes.

12.1 Schluter®-KERDI-BOARD-SN

is a prefabricated shower niche made of KERDI-BOARD that can be installed in both KERDI and KERDI-BOARD wall assemblies. The shower niche features a 1/2" (12.5 mm) -thick by 2" (50 mm) -wide integrated bonding flange and is available in 12" x 6" (30 x 15 cm), 12" x 12" (30 x 30 cm), 12" x 20" (30 x 51 cm), and 12" x 28" (30 x 71 cm) sizes.

Material Properties and Areas of Application

SHOWER-ST/-SC/-SR/-SB/-L/-LS prefabricated substrates are manufactured using lightweight expanded polystyrene. The products require no special disposal and can be recycled. No CFCs or HCFCs are present in either the products or in the manufacturing process. The polystyrene foam has a density of 2.75 lb/ft³ (44 kg/m³) with a 48 psi (331 kPa) compressive strength at 10% deformation. It is serviceable in temperatures up to 175°F (79 °C). The expanded polystyrene used to manufacture KERDI-SHOWER-ST/-SC/-SR/-SB is treated with a flame retarding agent. Expanded polystyrene should not be exposed to hydrocarbons, esters, amines, and aldehydes. All will deteriorate foam. Exposure to ultraviolet rays (sunlight) for long periods of time will result in partial

degradation (dusting) at the surface.

Waterproofing Membrane



8.1 Schluter®-KERDI

Since traditional shower pan liners are placed below the mortar setting bed in conventional assemblies, moisture is allowed to saturate the mortar bed. This can increase the risk of leakage, cause efflorescence, and foster mold growth. Bonded waterproof membranes, such as KERDI, are set on top of the mortar bed and protect it from becoming saturated, thus eliminating the problems associated with traditional systems.

Application and Function

8.1 Schluter®-KERDI is a pliable, sheet-applied, bonded waterproof membrane and vapor retarder with limited crack-bridging capabilities. It is made of soft polyethylene, which is covered on both sides with a special fleece webbing to anchor the membrane in the thin-set mortar. Tiles can be installed directly on the KERDI membrane using the thin-bed method. Other trowel-applied covering materials, such as plaster, can also be used. **Schluter®-KERDI-DS** is a bonded waterproof membrane and vapor retarder with very low water vapor permeance for use in continuous use steam rooms and similar applications.

Various KERDI waterproofing accessories are available. Preformed, seamless corners include the following. KERDI-KERECK-F are used to seal 90° inside and outside corners. KERDI-KERS-B are used to seal 135° corners at triangular shower benches and neo-angle shower curbs. KERDI-KERS are used to seal floor/wall/shower base connections in curbless shower applications



where the KERDI-LINE linear drain is installed adjacent to the wall. KERDI-SEAL-PS/-MV are prefabricated sections of KERDI with overmolded rubber gaskets that are used to seal pipe protrusions through the KERDI waterproofing membrane (e.g., at showerheads and tub spouts) and protect moisture-sensitive backing panels at the mixing valve. Use KERDI-BAND, in widths of 5" (12.5 cm), 7-1/4" (18.5 cm), or 10" (25 cm), to seal butt joints or corner joints. KERDI-FLEX, in 5" (12.5 cm) or 10" (25 cm) widths, is used to seal expansion joints or flexible edge joints.

Material Properties and Areas of Application

KERDI bonded waterproof membrane features a polyethylene core with a polypropylene fleece laminated to both sides. The material is physiologically safe and does not require special disposal. KERDI is 8-mil thick and has a water vapor permeance of 0.90 perms, when tested according to ASTM E96, using Procedure E at 90% relative humidity. KERDI-DS is 20-mil thick and features additives to produce a water vapor permeance of 0.18 perms.

KERDI and KERDI-DS are waterproof and resistant to most chemicals commonly encountered in tiled environments. They are resistant to aging and will not rot. KERDI and KERDI-DS are highly resistant to saline solutions, acid and alkaline solutions, many organic solvents, alcohols, and oils. Information regarding their resistance to specific substances can be provided if concentration, temperature, and duration of exposure are known. For acid-resistant coverings, use an epoxy adhesive to set and grout the tile.

KERDI and KERDI-DS are used on wall and floor surfaces where protection against the penetration of moisture or other harmful substances is necessary. KERDI is suitable for showers, intermittent use steam showers, tub surrounds, and areas surrounding swimming pools. Industrial applications include the food industry, breweries, and dairies. KERDI-DS is suitable for use in continuous use steam rooms and other applications with similar vapor management requirements.

KERDI and KERDI-DS meet the American National Standard for Load Bearing, Bonded, Waterproof Membranes for Thin-Set Ceramic Tile and Dimension Stone Installations (ANSI A118.10). The

membranes are listed by cUPC® and evaluated by ICC-ES (Report Nos. ESR-2467 and PMG-1204). For copies of these documents, please contact Schluter®-Systems at 800-472-4588 (USA) or 800-667-8746 (Canada) or by e-mail at info@schluter.com. Links to the documents can also be accessed at www.schluter.com.

Waterproof Building Panel



12.1 Schluter®-KERDI-BOARD

The KERDI-BOARD waterproof building panel simplifies shower installation by combining the tile backing and waterproofing installation into a single step. KERDI-BOARD gives tile setters more control over their projects by providing them with the means to simply and easily create ideal substrates for tile. Unsuitable substrates can be remedied and new substrates can be created while keeping the requirements of the tile covering in mind.

Application and Function

12.1 Schluter®-KERDI-BOARD is a multifunctional tile substrate and building panel, which can also be used for creating bonded waterproofing assemblies with tile coverings. It consists of an extruded polystyrene foam panel, with a special reinforcement material on both sides and fleece webbing for effective anchoring in thin-set mortar.

With the available panel thicknesses of 3/16", 3/8", 1/2", 5/8", 3/4", 1", 1-1/2", and 2" (5, 9, 12.5, 15, 19, 25, 38, and 50 mm), KERDI-BOARD covers a broad range of application areas for creating flat, level, plumb, square, and dimensionally stable substrates for the installation of ceramic and natural stone tiles. With suitable preparation of the abutting seams and joint areas, the panel may be used for bonded waterproofing assemblies.

KERDI-BOARD is suitable for: creating tile substrates on masonry walls, wood or metal framing, and other finished wall

surfaces; creating straight or curved partition walls; creating straight or curved bathtub and shower surrounds; concealing pipes and columns; as well as creating bathtub platforms, vanities, storage shelves, countertops, and various other bathroom structures.

The boards are simply cut to size with a utility knife. The gridlines, which are printed on the surface, are helpful for neat and quick cuts and installation. KERDI-BOARD can be fully adhered in wall areas or spot-bonded with thin-set mortar. If necessary, the material may be secured with additional wall anchors. In the case of stud framing, KERDI-BOARD is attached with screws and washers from the matching hardware system. Tiles can be installed directly over KERDI-BOARD using the thin-set method.

L-shaped and U-shaped KERDI-BOARD panels are available for creating pipe and column coverings, and grooved panels are available for creating curved elements. Schluter®-Systems also offers profiles and attachment hardware for wall connections and finishing edges, as well as matching wall anchors and screws.

Material Properties and Areas of Application

KERDI-BOARD is made from extruded polystyrene foam, with a cement-free reinforcement layer laminated to both sides and an anchoring fleece webbing. The surface of the board has gridlines consisting of 3/8" x 3/8" (10 x 10 mm) squares printed on one side.

KERDI-BOARD is waterproof and vapor retardant and can withstand all chemical stresses that typically occur in conjunction with ceramic tile coverings. KERDI-BOARD may be used in bonded waterproofing assemblies where required. KERDI-BOARD is completely flat and will not warp, even with one-sided exposure to temperature and moisture fluctuations. It will not rot or decay. KERDI-BOARD can be used in a multitude of different application areas. In special cases, the suitability of the material must be verified based on the anticipated chemical and mechanical stresses. The information provided below is intended as general guidelines.

Structures on which KERDI-BOARD is to be installed must be stable and meet any other project-specific requirements. Select a suitable material thickness if using

KERDI-BOARD for the construction of freestanding partition walls, shelving, or similar structures, and use reinforcement profiles as necessary. Arrange supports made of KERDI-BOARD at regular intervals consistent with conventional building practices. Select the material thickness and installation method depending on the evenness of the substrate. KERDI-BOARD can be spot-bonded to walls to correct substrate variations or fully embedded in thin-set mortar where walls are sufficiently even and plumb.

Maintenance

Storage

KERDI-BOARD should be stored flat. In case of outdoor storage, protect the material from direct sunlight and weather exposure.

Shower Drains

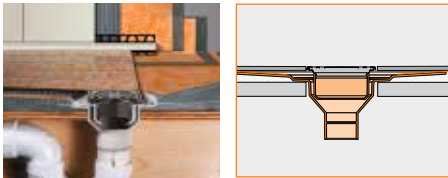

8.2 Schluter®-KERDI-DRAIN

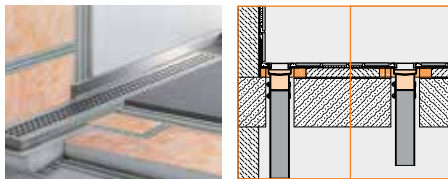

8.7 Schluter®-KERDI-LINE

Conventional two-stage drains are designed to connect to shower pan liners below the mortar bed and do not allow a secure, watertight connection to bonded waterproof membranes at the top of the drain assembly. KERDI-DRAIN and KERDI-LINE are designed specifically to ensure a simple and secure connection to bonded waterproof membranes, such as KERDI, at the top of the assembly rather than below it, thereby reducing the risk of leakage, efflorescence, and mold growth.

Application and Function

8.2 Schluter®-KERDI-DRAIN is a floor drain specifically designed to allow connections to KERDI or other load-

12.1 Schluter®-KERDI-BOARD

Property	Method	Value
Water vapor permeance	ASTM E96 ¹	0.36 perms - 1/2" (12.5 mm)
Thermal resistance (R-value)	ASTM C518	R 9.1 - 2" (50 mm) R 2.2 - 1/2" (12.5 mm) R 0.9 - 3/16" (5 mm)
Service temperature range		-58°F to 158°F (-50°C to 70°C)
Flame spread/smoke developed	ASTM E84	Pass ²
Thermal barrier evaluation	NFPA 286	Pass ^{2,3}

¹ Using the desiccant method at 100°F (38°C) and 90% RH

² Per International Building Code Requirements

³ Porcelain tile used as thermal barrier over 1/2" (12.5 mm) -thick KERDI-BOARD on wood framing

bearing, bonded waterproof membranes. The membrane is adhered to the large integrated bonding flange to form a waterproof connection at the top of the drain assembly. KERDI-DRAIN consists of a drain casing and fully adjustable grate assembly or covering support to which tile is applied. The grate assembly accommodates a wide range of tile thicknesses and allows lateral and tilt adjustment as well. The covering support is placed flush with the top of the bonding flange and can therefore accommodate any thickness tile covering. The standard KERDI-DRAIN is attached directly to the waste line. The drain casing is available in ABS, PVC, or stainless steel. The plastic drain casings feature a fleece-covered bonding flange. They are available with standard 2" (50 mm) and 3" (75 mm) outlets and attached to the pipe using an appropriate solvent cement. The stainless steel drain casings are available with standard 2" (50 mm) or 3" (75 mm) no-hub outlets or 2" (50 mm) threaded outlet. The no-hub outlets are attached to the pipe using an appropriate mechanical (e.g., flexible or no-hub) coupling. The threaded outlets are attached to the pipe using thread sealing compound or tape. The simple connection to standard drain outlets makes KERDI-DRAIN suitable for new construction and renovation.

The KERDI-DRAIN adaptor kit is designed to convert clamping ring drains by equipping them with an integrated bonding flange. The adaptor kit includes a stainless steel adaptor ring with an over-molded rubber gasket and a variety of perforated hole patterns that align with most common clamping ring shower drains. The adaptor ring replaces the clamping ring and is attached to the drain body using the clamping ring bolts. This connection is made watertight via the rubber gasket and KERDI-FIX adhesive/sealant. The integrated bonding flange slides into the adaptor ring, with the over-molded rubber gasket ensuring a watertight seal. Commercial KERDI-DRAIN

adaptor kits feature a 7-1/2" (191 mm) diameter adaptor ring and are available with a stainless steel bonding flange or an ABS bonding flange. The ABS bonding flange is available in two sizes (standard or extended length) to accommodate different tile assembly thicknesses. The residential KERDI-DRAIN adaptor kit features a 5-1/4" (133 mm) diameter adaptor ring and an ABS bonding flange. The KERDI-DRAIN adaptor kit is particularly useful in renovations where the clamping ring drains are difficult to replace with the standard KERDI-DRAIN (e.g., when they are set in concrete slabs). The grate assembly consists of a height adjustment collar, lateral adjustment ring, and drain grate or covering support. The grates are installed in conjunction with a height adjustment collar and lateral adjustment ring, which are made of ABS or stainless steel, to allow for simple and convenient adjustment when setting the tile. Drain grates are available in stainless steel with a polished or oil-rubbed bronze finish and in anodized aluminum with a brushed copper, brushed brass, or brushed nickel finish. The polished stainless steel grates are available in 4" (100 mm) -square, 6" (150 mm) -square and -round versions. All other grates are available in the 4" (100 mm) -square version only. Please note that grate assemblies included with the plastic KERDI-DRAIN featuring 3" (75 mm) outlets and the residential adaptor kits only allow vertical and tilt adjustment (no lateral adjustment). The covering support is a 4" (100 mm) -square stainless steel plate with KERDI laminated on the surface to allow for bonding of ceramic or stone tile, which creates a virtually invisible drainage line.

8.7 Schluter®-KERDI-LINE is a low profile linear floor drain specifically designed for bonded waterproofing assemblies. KERDI-LINE can be installed adjacent to walls or at intermediate locations. The floor can be sloped on a single plane to KERDI-



LINE, which enables the use of large-format tiles and creates interesting design opportunities.

KERDI-LINE consists of a formed stainless steel channel body and grate assembly or covering support to which tile is applied. The channel body features a standard 2" (50 mm) no-hub outlet and is attached to the pipe using an appropriate mechanical (e.g., flexible or no-hub) coupling. The simple connection to standard drain outlets makes KERDI-LINE suitable for new construction and renovation. KERDI-LINE is available with both center and off-set outlets. The off-set outlet is located 8" (20.3 cm) from the edge of the channel body and provides flexibility when obstacles (e.g., floor joists) are encountered during installation. The grate assembly can be seamlessly adjusted to the thickness of the ceramic tile or stone covering from 1/8" to 1" (3 mm to 25 mm). The covering support is placed flush with the top of the channel body and can therefore accommodate any thickness tile covering.

KERDI-LINE includes a corresponding polystyrene foam channel support. The perimeter of the channel body consists of a bonding flange laminated with a collar made of KERDI. It ensures a simple and secure connection to the bonded waterproofing assembly, both in the floor area and on adjacent walls.

The grate assembly consists of a brushed stainless steel frame and two design grate options. Option A is a closed-design, brushed stainless steel grate. Option B is a brushed stainless grate with square perforations. Option B is also available with a locking mechanism (3/4" - 19 mm frame only) for applications where tamper resistance is desired or required (e.g., healthcare and education facilities, etc.). The covering support D is a stainless steel plate with KERDI waterproofing membrane laminated on the surface to allow for bonding of ceramic or stone tile, which creates a virtually invisible drainage line. KERDI-LINE is available in channel lengths from 20" to 72" (50 cm to 180 cm) in 4" (10 cm) increments. Please note that the bonding flange extends approximately 1" (2.5 cm) beyond the channel on all sides.

Schluter®-KERDI-LINE-FC is a stainless steel cover plate for use with KERDI-LINE to create a seamless look in applications where multiple drains are installed end-to-end. KERDI-LINE-FC features a brushed finish, and is designed for use with either the solid or perforated grates with brushed

stainless steel frame.

14.1 Schluter®-SHOWERPROFILE-S/-R system profiles represent an elegant solution for finishing the area between the floor and the first course of wall tile in a way that eliminates cutting wedges of tile and ensures a consistent elevation of the first course of wall tile in KERDI-LINE applications. SHOWERPROFILE-S consists of a trapezoid-perforated anchoring leg with a groove, which accepts a tapered brushed stainless steel profile that matches the slope of the KERDI-SHOWER-L shower tray. The profile is adjusted to cover the exposed wall area and forms the visible surface. SHOWERPROFILE-R consists of a brushed stainless steel profile and corresponding channel. The profile is adjusted to fit the space between the KERDI-LINE and the wall tile and forms the visible surface in applications where the KERDI-LINE is placed adjacent to a wall.

Material Properties and Areas of Application

KERDI-DRAIN drain casings are formed using ABS, PVC, or stainless steel 304 (1.4301 = V2A). Plastic drain casings feature a polypropylene fleece webbing. The KERDI-DRAIN adaptor kits feature adaptor rings made of stainless steel 304 (1.4301 = V2A) with thermoplastic rubber gaskets and adaptor flanges made of stainless steel 304 (1.4301 = V2A) or ABS. Drain grates are available in stainless steel 304 (1.4301 = V2A) and anodized aluminum. The covering support is stainless steel 304 (1.4301 = V2A) with KERDI laminated on the surface.

The KERDI-LINE channel body is formed using stainless steel 316 L (1.4404 = V4A) and features a bonding flange with a KERDI collar laminated on the surface. KERDI is a bonded waterproof membrane made of soft polyethylene, which is covered on both sides with a special fleece webbing to anchor the membrane in the thin-set mortar. The frame and grates are made of stainless steel 316 L (1.4404 = V4A). The channel support is made of pressure-resistant, expanded polystyrene (EPS).

KERDI-DRAIN and KERDI-LINE are suitable for use in residential and commercial applications, including areas subject to foot and wheelchair traffic, such as showers and wet rooms in homes, hotels, schools, healthcare facilities, etc.

Stainless steel can sustain high mechanical stresses and is particularly suitable for

applications requiring resistance against chemicals and acids. However, even stainless steel is not resistant to all chemical stresses, and may be affected by hydrochloric acid, hydrofluoric acid or certain chlorine, chloride, and brine concentrations, which may be present in detergents or swimming pools. In special cases, the suitability of the selected floor drainage system must be verified based on the anticipated chemical, mechanical, and/or other stresses.

Anodized aluminum retains a uniform appearance during normal use. The surface, however, is susceptible to scratching and wear and may be damaged by grout or setting material. Therefore, these materials must be removed immediately.

Various configurations of KERDI-DRAIN and KERDI-LINE are listed by UPC®, CSA, ICC-ES PMG and NSF. Relevant industry standard guidelines for floor drains with integrated bonding flange include method B422 in the Tile Council of North America's (TCNA) Handbook for Ceramic Tile Installation and Method 326DR in the Terrazzo, Tile and Marble Association of Canada (TTMAC) Specification Guide 09300 Tile Installation Manual.

The KERDI-LINE-FC is roll-formed using stainless steel 316 L (1.4404 = V4A).

The SHOWERPROFILE-S anchoring leg is made of recycled, rigid PVC. The SHOWERPROFILE-S/-R profiles are made of stainless steel 316 L (1.4404 = V4A) with KERDI laminated on the backside.

Maintenance

KERDI-DRAIN, KERDI-LINE, and SHOWERPROFILE-S/-R require no special maintenance and are resistant to mold and fungi. The drain grates may be removed to clean the drain housing and the drain pipes.

Clean the grates and profiles using common household cleaning agents. Stainless steel exposed to the environment or aggressive substances should be cleaned periodically using a mild household cleaner. Regular cleaning maintains the neat appearance of stainless steel and reduces the risk of corrosion. All cleaning agents must be free of hydrochloric acid, hydrofluoric acid, and chlorides. Stainless steel surfaces develop a sheen when treated with a chrome-polishing agent. Do not use abrasive or alkaline cleaning agents.

Shower Profiles



14.2 Schluter®-WS/-WSC/-WSL



14.2 Schluter®-WSK/-WSC/-WSL

Application and Function

14.2 Schluter®-SHOWERPROFILE-WS/-WSK system profiles, together with the Schluter®-SHOWERPROFILE-WSL/-WSC inserts, form a splashguard at the entrance of curbless showers.

Schluter®-SHOWERPROFILE-WS is an anodized aluminum support profile that is set in conjunction with the tile using thin-set mortar. It has a 3/4" (19 mm) –wide visible surface and a height of 5/16" (8 mm). Where thicker tiles are used, simply fill the space below the profile with thin-set mortar.

Schluter®-SHOWERPROFILE-WSK is an anodized aluminum support profile that is adhered to the tile surface. It has a 2-1/16" (52 mm) –wide visible surface and a height of 5/16" (8 mm).

The support profiles are combined with either the SHOWERPROFILE-WSL insert or the SHOWERPROFILE-WSC insert.

Schluter®-SHOWERPROFILE-WSL is an upright insert made of transparent polyurethane. The insert is collapsible when stepped on or rolled over with a wheelchair. The insert protrudes 1-5/32" (29 mm) above the profile surface. The SHOWERPROFILE-WSL insert does not comply with the Americans with Disabilities Act (ADA), since it exceeds the allowable height of a vertical transition despite being collapsible. Please check with local code officials for acceptance on projects where ADA guidelines must be observed before installation.

Schluter®-SHOWERPROFILE-WSC is a semi-circular insert made of semi-rigid PVC. The insert creates an inconspicuous transition from the shower area to the adjoining space and a 5/8" (16 mm) –wide

visible surface. The insert protrudes 3/64" (1.2 mm) above the profile surface. The SHOWERPROFILE-WSC insert complies with the Americans with Disabilities Act (ADA).

The SHOWERPROFILE-WS/-WSK support profiles feature an anodized aluminum layer that retains uniform appearance during normal use. The surface, however, is susceptible to scratching and wear and may be damaged by grout or setting material. Cementitious materials, in conjunction with moisture, become alkaline. Since aluminum is sensitive to alkaline substances, exposure to the alkali (depending on the concentration and duration of exposure) may result in corrosion (aluminum hydroxide formation). Therefore, it is important to remove mortar or grout residue immediately from visible surfaces. In addition, ensure the profile is solidly embedded in the setting material and that all cavities are filled to prevent the collection of alkaline water.

The SHOWERPROFILE-WSL insert is made of highly flexible polyurethane.

The SHOWERPROFILE -WSC insert is made of semi-rigid PVC.

The inserts can withstand chemical stresses typically encountered in tiled environments.

Maintenance

SHOWERPROFILE-WS/-WSK support profiles require no special maintenance or care and are resistant to mold and fungi. In the case of anodized aluminum, do not use abrasive cleaning agents. The SHOWERPROFILE-WSC/ -WSL inserts are specifically treated to resist the growth of fungi and bacteria and require no special maintenance or care.

Adhesive/Sealant



8.3 Schluter®-KERDI-FIX

Any protrusions through the KERDI membrane can be treated with KERDI-FIX, or equivalent sealant, to ensure a fully

waterproof assembly.

Application and Function

8.3 Schluter®-KERDI-FIX is a single-component, waterproof sealing and bonding compound with a silane-modified polymer base, which can be used in various applications. In conjunction with KERDI, KERDI-FIX can be used to waterproof pipe and valve protrusions in the Schluter®-Shower System. KERDI-FIX is used to bond the KERDI membrane to the stainless steel KERDI-DRAIN bonding flange. KERDI-FIX can also be used to bond KERDI to building elements such as bathtubs, window elements and door frames.

Material Properties and Areas of Application

KERDI-FIX has been independently tested to determine VOC emissions per California Specification 01350: "Standard Practice for the Testing of Volatile Organic Emissions from Various Sources Using Small-Scale Environmental Chambers", found to emit zero VOCs, and can contribute towards achieving the following green building credits:

- LEED, IEQ Credit 4.3: Low-Emitting Materials - Flooring Systems
- ICC 700-2008, 901.6: Pollutant Source Control - Hard-Surface Flooring
- CHPS, EQ2.2: Low-Emitting Materials

Maintenance

Storage

Unopened packages of KERDI-FIX can be stored in a cool place for up to 18 months. Once the cartridge has been opened, the material has a limited shelf life.

System Installation

For complete installation guidelines and warranty criteria for shower applications, please contact Schluter®-Systems at 800-472-4588 (USA) or 800-667-8746 (Canada) to receive a copy of the Schluter®-Shower System Installation Handbook and a step-by-step installation video. To download a PDF version of the Handbook or to view the installation video online, please visit www.schluter.com.



Schluter®-KERDI-FIX Technical Data	
Color	Grey or bright white
Basic raw material	Silyl-modified polymer (SMP)
Specific weight	Approx. 93.6 lb/ft ³ (1.5 g/ml)
Solvent content	0%
Isocyanate content	0%
Dry materials content	Approx. 100%
VOC emissions	0.0 mg/m ³
Shear strength beech wood/beech wood	Approx. 435 psi (3 N/mm ²)
Shear strength aluminum/aluminum	Approx. 290 psi (2 N/mm ²)
Elongation at failure	Approx. 200%
Skinning	About 10 minutes
Curing	1/8" (3 mm) per 24 hours
Permissible total movement	About 20%
Processing temperatures	Don't install at temperatures below 40 °F (5 °C)
Temperature stability	-40 °F (-40 °C) to 212 °F (100 °C), temporarily 356 °F (180 °C) [max. 30 minutes]
Moisture resistance	Very good
Frost ability	Not sensitive to frost
Cartridge volume	9.81 oz (290 ml)
Estimated coverage	
5" (12.7 cm) connection to fixed building elements	12' 10" (3.9 m) per cartridge
1/4" (6 mm) bead	30' 1" (9.2 m) per cartridge

Product Item Numbers



8.3 Schluter®-KERDI-SHOWER-ST Prefabricated EPS shower tray				
Item No.	Width	Length	Perimeter Height	Drain Placement
ST 122	48" - 122 cm	48" - 122 cm	1-1/4" - 3.2 cm	Center
ST-81/152	32" - 81 cm	60" - 152 cm	1-3/4" - 4.4 cm	Center
ST-81/152 BR	32" - 81 cm	60" - 152 cm	1-1/2" - 3.8 cm	Off-center*
ST-183	72" - 183 cm	72" - 183 cm	1-1/2" - 3.8 cm	Center

*Off-center drain at 10" (25 cm) from end of tray



8.8 Schluter®-KERDI-SHOWER-LS Shower tray - wall drain placement				
Item No.	Width	Length	End Height	
KSL 1000 S	39" - 100 cm	39" - 100 cm	1-21/32" - 42 mm	
KSL 1400 S	55" - 140 cm	55" - 140 cm	2" - 50 mm	



8.8 Schluter®-KERDI-SHOWER-L Shower tray - center drain placement				
Item No.	Width	Length	End Height	
KSL 1000	39" - 100 cm	39" - 100 cm	1-1/4" - 32 mm	
KSL 1400	55" - 140 cm	55" - 140 cm	1-13/32" - 36 mm	



8.3 Schluter®-KERDI-SHOWER-SC Prefabricated EPS curb			
Item No.	Width	Length	Height
SC 122	4-1/2" - 11.5 cm	48" - 122 cm	6" - 15 cm



8.3 Schluter®-KERDI-SHOWER-SR Prefabricated EPS ramp			
Item No.	Width	Length	Height
SR 122	48" - 122 cm	15-7/8" - 40 cm	1-1/2" - 3.8 cm

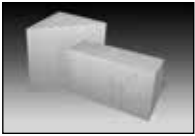

8.3 Schluter®-KERDI-SHOWER-SB

Prefabricated EPS bench

Item No.	Width	Depth	Height	Shape
SB 41	16" – 41 cm	16" – 41 cm	20" – 51 cm	Triangular
SB 2981	32" – 81 cm	11-1/2" – 29 cm	20" – 51 cm	Rectangular
SB 29107	42" – 107 cm	11-1/2" – 29 cm	20" – 51 cm	Rectangular
SB 29122	48" – 122 cm	11-1/2" – 29 cm	20" – 51 cm	Rectangular
SB 4181	32" – 81 cm	16" – 41 cm	20" – 51 cm	Rectangular
SB 41122	48" – 122 cm	16" – 41 cm	20" – 51 cm	Rectangular



8.1 Schluter®-KERDI

Waterproofing membrane

Item No.	Width	Length	Area	Thickness
KERDI 200/5M	3' 3" – 1 m	16' 5" – 5 m	54 ft ² – 5 m ²	8 mil
KERDI 200/10M	3' 3" – 1 m	33' – 10 m	108 ft ² – 10 m ²	8 mil
KERDI 200/20M	3' 3" – 1 m	65' 7" – 20 m	215 ft ² – 20 m ²	8 mil
KERDI 200	3' 3" – 1 m	98' 5" – 30 m	323 ft ² – 30 m ²	8 mil

8.1 Schluter®-KERDI-DS

Waterproofing membrane

Item No.	Width	Length	Area	Thickness
KERDI-DS	3' 3" – 1 m	98' 5" – 30 m	323 ft ² – 30 m ²	20 mil



12.1 Schluter®-KERDI-BOARD

Waterproof building panel

Item No.	Width	Length	Thickness
KB 12 1220 812	48" – 122 cm	32" – 81 cm	1/2" – 12.5 mm
KB 5 1220 1625	48" – 122 cm	64" – 162.5 cm	3/16" – 5 mm
KB 9 1220 1625	48" – 122 cm	64" – 162.5 cm	3/8" – 9 mm
KB 12 1220 1625	48" – 122 cm	64" – 162.5 cm	1/2" – 12.5 mm
KB 5 1220 2440	48" – 122 cm	96" – 244 cm	3/16" – 5 mm
KB 9 1220 2440	48" – 122 cm	96" – 244 cm	3/8" – 9 mm
KB 12 1220 2440	48" – 122 cm	96" – 244 cm	1/2" – 12.5 mm
KB 15 1220 2440	48" – 122 cm	96" – 244 cm	5/8" – 15 mm
KB 19 625 2440	24-1/2" – 62.5 cm	96" – 244 cm	3/4" – 19 mm
KB 25 625 2440	24-1/2" – 62.5 cm	96" – 244 cm	1" – 25 mm
KB 38 625 2440	24-1/2" – 62.5 cm	96" – 244 cm	1-1/2" – 38 mm
KB 50 625 2440	24-1/2" – 62.5 cm	96" – 244 cm	2" – 50 mm
KB 15 1220 3050	48" – 122 cm	120" – 305 cm	5/8" – 15 mm



12.1 Schluter®-KERDI-BOARD-SN

Shower niche

Item No.	Size	Depth	Shelf
KB 12 SN 305 152 A	12" x 6" – 305 x 152 mm	3-1/2" – 89 mm	-
KB 12 SN 305 305 A	12" x 12" – 305 x 305 mm	3-1/2" – 89 mm	-
KB 12 SN 305 508 A1	12" x 20" – 305 x 508 mm	3-1/2" – 89 mm	1
KB 12 SN 305 711 A1	12" x 28" – 305 x 711 mm	3-1/2" – 89 mm	1



8.1 Schluter®-KERDI-BAND Waterproofing strip

Item No.	Width	Length	Thickness
KEBA 100/125/5M	5" – 12.5 cm	16' 5" – 5 m	4 mil
KEBA 100/125/10M	5" – 12.5 cm	33' – 10 m	4 mil
KEBA 100/185/5M	7-1/4" – 18.5 cm	16' 5" – 5 m	4 mil
KEBA 100/250/5M	10" – 25 cm	16' 5" – 5 m	4 mil
KEBA 100/125	5" – 12.5 cm	98' 5" – 30 m	4 mil
KEBA 100/185	7-1/4" – 18.5 cm	98' 5" – 30 m	4 mil
KEBA 100/250	10" – 25 cm	98' 5" – 30 m	4 mil



8.1 Schluter®-KERDI-FLEX Waterproofing strip for use above movement joints

Item No.	Width	Length	Thickness
FLEX 125/5M	5" – 12.5 cm	16' 5" – 5 m	12 mil
FLEX 250/5M	10" – 25 cm	16' 5" – 5 m	12 mil
FLEX 125/30	5" – 12.5 cm	98' 5" – 30 m	12 mil
FLEX 250/30	10" – 25 cm	98' 5" – 30 m	12 mil



8.1 Schluter®-KERDI-KERECK-F Preformed corner

Item No.	Thickness	Packaging
KERECK / FI 2	4 mil	2 inside corners
KERECK / FI 10	4 mil	10 inside corners
KERECK / FA 2	4 mil	2 outside corners
KERECK / FA 10	4 mil	10 outside corners



8.1 Schluter®-KERDI-KERS-B Preformed corner

Item No.	Thickness	Description	Packaging
KERECK135/FI2	4 mil	Inside corner, 135°	2 units
KERECK135/FI10	4 mil	Inside corner, 135°	10 units
KERSB135KLR	4 mil	Bench corners	1 right and 1 left
KERSB135K5LR	4 mil	Bench corners	5 right and 5 left
KERSB135K	4 mil	Bench/ neo-angle corner kit	1 right and 1 left bench corner, and 2 135° inside corners



8.1 Schluter®-KERDI-KERS Preformed corner

Item No.	Thickness	Packaging
KERS 20L	4 mil	Left inside corner – 20 mm
KERS 28L	4 mil	Left inside corner – 28 mm
KERS 20R	4 mil	Right inside corner – 20 mm
KERS 28R	4 mil	Right inside corner – 28 mm



8.1 Schluter®-KERDI-SEAL-PS Pipe seal with over-molded rubber gasket

Item No.	Pipe nipple opening diam.	Thickness	Packaging
KMS 185/12	1/2" – 12.5 cm	4 mil	1 unit
KMS 185/20	3/4" – 20 cm	4 mil	1 unit
KMS 10185/12	1/2" – 12.5 cm	4 mil	10 units
KMS 10185/20	3/4" – 20 cm	4 mil	10 units



8.1 Schluter®-KERDI-SEAL-MV Mixing valve seal with over-molded rubber gasket

Item No.	Mixing valve opening diam.	Thickness	Packaging
KMSMV 235/114	4-1/2" – 114 cm	4 mil	1 unit
KMSMV 10235/114	4-1/2" – 114 cm	4 mil	10 units



8.1 Schluter®-KERDI-KM Pipe seal

Item No.	Dimensions	Thickness	Packaging
KM 5117/22	7" x 7" - 17 x 17 cm	4 mil	5 units

Hole diameter, $\phi = 7/8"$ - 22 mm



14.2 Schluter®-SHOWERPROFILE-WS Support profile

Item No.	Height	Length
SPWS 19 AE/100	5/16" - 8 mm	39" - 1 m
SPWS 19 AE	5/16" - 8 mm	8' 2-1/2" - 2.5 m



14.2 Schluter®-SHOWERPROFILE-WSK Support profile - retrofit

Item No.	Height	Length
SPWSK 52 AE/100	5/16" - 8 mm	39" - 1 m
SPWSK 52 AE	5/16" - 8 mm	8' 2-1/2" - 2.5 m



14.2 Schluter®-SHOWERPROFILE-WSC Semi-circular lip insert

Item No.	Height	Length
SPWSC 16 GS/100	5/16" - 8 mm	39" - 1 m
SPWSC 16 GS	5/16" - 8 mm	8' 2-1/2" - 2.5 m



14.2 Schluter®-SHOWERPROFILE-WSL Straight lip insert

Item No.	Height	Length
SPWSL 30 T/100	5/16" - 8 mm	39" - 1 m
SPWSL 30 T	5/16" - 8 mm	8' 2-1/2" - 2.5 m

14.2 Schluter®-SHOWERPROFILE-WSK-EK End cap

Item No.	Height
EK/SPWSK 52 AE	5/16" - 8 mm



Schluter®-KERDI-TROWEL Trowel

Item No.	Notch Size	Packaging
TRL-KER6	1/8" x 1/8" - 3 x 3 mm	6 units



8.3 Schluter®-KERDI-FIX Adhesive/sealant

Item No.	Cartridge Volume
KERDIFIX / <i>color</i> *	9.81 oz - 290 ml

***Color Codes**



To complete the item number, add the *color* code (e.g., KERDIFIX / BW).



8.2 Schluter®-KERDI-DRAIN



4" Grate Options			
Tileable Covering Support	Anodized Aluminum		Stainless Steel
<p>(ECS)</p> <p>Patent pending</p>	<p>Brushed nickel (ATGB)</p>	<p>Brushed copper (AKGB)</p>	<p>Brushed brass (AMGB)</p>
			<p>Oil-rubbed bronze (EOB)</p>
			<p>Stainless steel (E)</p>



6" Grate Options			
Stainless Steel		Stainless Steel Cover for Cleanout Applications	
<p>(6E)</p>	<p>(6RE)</p>	<p>(6CE)</p>	<p>(6RCE)</p>

Flange Options			
ABS - 2" or 3" Outlet	PVC - 2" or 3" Outlet	Stainless Steel - 2" or 3" No-hub Outlet	Stainless Steel - 2" Threaded Outlet

Listings and certifications can be referenced on page 19.



DRAIN KITS - ABS or PVC FLANGE - 2" OR 3" OUTLET

Schluter®-KERDI-DRAIN - Components - ABS or PVC Flange			
	Includes	Description	Quantity
	1 KERDI-DRAIN	Drain with integrated bonding flange and grate assembly	1
	2 KERDI-KERECK-F	Preformed waterproofing corners	4 inside and 2 outside
	3 KERDI-SEAL-PS	Pipe seal (3/4" - 20 mm)	1
	4 KERDI-SEAL-MV	Mixing valve seal	1

2" Drain Outlet		
	ABS flange	PVC flange
4" (100 mm) Square Grate		
Tileable covering support (ECS)*	KD2/ABS/ECS ¹	KD2/PVC/ECS ¹
Stainless steel (E)	KD2/ABS/E ¹	KD2/PVC/E ¹
Oil-rubbed bronze stainless steel (EOB)	KD2/ABS/EOB	KD2/PVC/EOB
Brushed brass anod. alu. (AMGB)	KD2/ABS/AMGB ¹	KD2/PVC/AMGB ¹
Brushed copper anod. alu. (AKGB)	KD2/ABS/AKGB ¹	KD2/PVC/AKGB ¹
Brushed nickel anod. alu. (ATGB)	KD2/ABS/ATGB ¹	KD2/PVC/ATGB ¹
6" (150 mm) Square or Round Grate		
Square grate stainless steel (6E)	KD2/ABS/6E ¹	KD2/PVC/6E ¹
Round grate stainless steel (6RE)	KD2/ABS/6RE ¹	KD2/PVC/6RE ¹

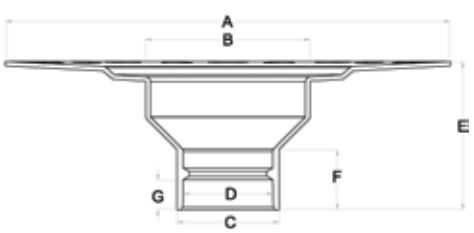

3" Drain Outlet		
	ABS flange	PVC flange
6" (150 mm) Square or Round Grate		
Square grate stainless steel (6E)	KD3/ABS/6E ¹	KD3/PVC/6E ¹
Round grate stainless steel (6RE)	KD3/ABS/6RE ¹	KD3/PVC/6RE ¹

¹ Listed by UPC®, CSA, ICC-ES PMG, and NSF
 * Patent pending

Flange Measurements			
ABS or PVC			
		2" (50 mm) drain outlet	3" (75 mm) drain outlet
	A	11-13/16" - 300 mm	11-13/16" - 300 mm
	B	4-17/32" - 115.2 mm	4-17/32" - 115.2 mm
	C	2-45/64" - 68.6 mm	3-15/16" - 100 mm
	D	2-3/8" - 60.5 mm	3-1/2" - 88.8 mm
	E	3-15/16" - 100 mm	3-15/16" - 100 mm
	F	1-39/64" - 40.6 mm	2" - 50.8 mm
	G	7/8" - 22.5 mm	1-1/2" - 38.1 mm



DRAIN KITS - STAINLESS STEEL FLANGE - 2" OR 3" NO-HUB OUTLET

Schluter®-KERDI-DRAIN - Components - Stainless Steel Flange			
1	Includes	Description	Quantity
	1 KERDI-DRAIN	Drain with integrated bonding flange and grate assembly	1
	2 KERDI-KERECK-F	Preformed waterproofing corners	4 inside and 2 outside
	3 KERDI-SEAL-PS	Pipe seal (3/4" - 20 mm)	1
	4 KERDI-SEAL-MV	Mixing valve seal	1
	5 KERDI-FIX	Sealing and bonding compound (66 ml)	1

2" No-hub Outlet	
	Stainless steel flange
4" (100 mm) Square Grate	
Tileable covering support (ECS)*	KD2/E/ECS ¹
Stainless steel (E)	KD2/E/E ¹
Oil-rubbed bronze stainless steel (EOB)	KD2/E/EOB
Brushed brass anod. alu. (AMGB)	KD2/E/AMGB ¹
Brushed copper anod. alu. (AKGB)	KD2/E/AKGB ¹
Brushed nickel anod. alu. (ATGB)	KD2/E/ATGB ¹
6" (150 mm) Square or Round Grate	
Square grate stainless steel (6E)	KD2/E/6E ¹
Round grate stainless steel (6RE)	KD2/E/6RE ¹

3" No-hub Outlet	
	Stainless steel flange
6" (150 mm) Square or Round Grate	
Square grate stainless steel (6E)	KD3/E/6E ¹
Round grate stainless steel (6RE)	KD3/E/6RE ¹

¹ Listed by UPC®, CSA, ICC-ES PMG, and NSF
 * Patent pending

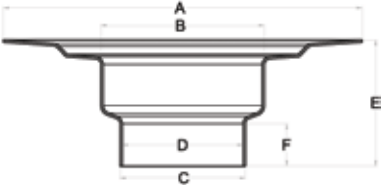
Flange Measurements			
Stainless steel			
		2" (50 mm) no-hub outlet	3" (75 mm) no-hub outlet
	A	9-27/32" - 250 mm	9-27/32" - 250 mm
	B	4-1/2" - 115.4 mm	4-1/2" - 114 mm
	C	2-13/32" - 61.3 mm	3-7/16" - 87.4 mm
	D	2-13/32" - 60.6 mm	3-5/16" - 84.2 mm
	E	3-11/32" - 85 mm	3-7/16" - 87.4 mm
	F	53/64" - 21 mm	1-5/32" - 29.4 mm

GRATE & FLANGE KITS (sold separately)

Grate Kit - Components		
		Patent pending
		
Includes	Description	Quantity
1a 1b Grate Assembly	a) For stainless steel and aluminum grates b) For tileable covering support	1
2 KERDI-KERECK-F	Preformed waterproofing corners	4 inside and 2 outside
3 KERDI-SEAL-PS	Pipe seal (3/4" - 20 mm)	1
4 KERDI-SEAL-MV	Mixing valve seal	1

Grate Kits	
Finish	Item No.
4" (100 mm) Square Grate	
Tileable covering support (ECS)*	KD2/ECS/GR
Stainless steel (E)	KD2/E/GR
Oil-rubbed bronze stainless steel (EOB)	KD2/EOB/GR
Brushed brass anod. alu. (AMGB)	KD2/AMGB/GR
Brushed copper anod. alu. (AKGB)	KD2/AKGB/GR
Brushed nickel anod. alu. (ATGB)	KD2/ATGB/GR
Stainless steel (E) with stainless steel height adjustment collar and lateral adjustment ring	KD2/E/E/GR
6" (150 mm) Square or Round Grate	
Square grate stainless steel (6E)	KD2/6E/GR
Round grate stainless steel (6RE)	KD2/6RE/GR
6" (150 mm) Square or Round Cover	
Square cover stainless steel (6CE)	KD-GR6C-E
Round cover stainless steel (6RCE)	KD-GR6RC-E

Note: 6" square and round covers do not include the seals and corners.

Flange Kit - Components	
	
Includes	Quantity
Drain with integrated bonding flange	1

Flange Kits		
Material	Item No.	\$ / Unit
2" (50 mm) Drain Outlet		
ABS	KD2/ABS/FL	26.45
PVC	KD2/PVC/FL	26.45
Stainless Steel with no-hub outlet	KD2/E/FL	169.60
Stainless Steel with threaded outlet	KD2/ETH/FL	182.50
3" (75 mm) Drain Outlet		
ABS	KD3/ABS/FL	35.69
PVC	KD3/PVC/FL	35.69
Stainless Steel with no-hub outlet	KD3/E/FL	169.60



Please note that flanges with 3" outlets are intended for use with 6" grates as these combinations have listings and certifications while flanges with 3" outlet combined with 4" grates do not. Please refer to the Product Listings and Certifications Table on page 19.



DRAIN ADAPTOR KIT FOR USE WITH RESIDENTIAL CLAMPING RING DRAINS - ABS

Schluter®-KERDI-DRAIN with residential adaptor ring and ABS flange			
	Includes	Description	Quantity
	1 KERDI-DRAIN	Drain with integrated bonding flange and grate assembly	1
	2 Adaptor ring*	For residential clamping ring drains	1
	3 KERDI-KERECK-F	Preformed waterproofing corners	4 inside and 2 outside
	4 KERDI-SEAL-PS	Pipe seal (3/4" - 20 mm)	1
	5 KERDI-SEAL-MV	Mixing valve seal	1
	6 KERDI-FIX	Sealing and bonding compound (66 ml)	1

* © Schluter-Systems L.P., U.S. patent No. D593,641, other patents pending

Residential Adaptor Kits - ABS Flange	
	ABS bonding flange
4" (100 mm) Square Grate	
Stainless steel (E)	KDAR/ABS/E
Oil-rubbed bronze stainless steel (EOB)	KDAR/ABS/EOB
Brushed brass anod. alu. (AMGB)	KDAR/ABS/AMGB
Brushed copper anod. alu. (AKGB)	KDAR/ABS/AKGB
Brushed nickel anod. alu. (ATGB)	KDAR/ABS/ATGB

Flange and adaptor ring measurements - Residential		
ABS		
	A	11-13/16" - 300 mm
	B	2-13/32" - 60.7 mm
	C	2.73" - 69.3 mm
	D	5-1/4" - 133.4 mm
	E	2-29/32" - 74 mm
	F	1-1/64" - 25.9 mm
	G	2-1/16" - 52.6 mm



DRAIN ADAPTOR KIT FOR USE WITH COMMERCIAL CLAMPING RING DRAINS - ABS

Schluter®-KERDI-DRAIN with commercial adaptor ring and ABS flange			
	Includes	Description	Quantity
	1 KERDI-DRAIN	Drain with integrated bonding flange and grate assembly	1
	2 Adaptor ring*	For commercial clamping ring drains	
	3 KERDI-FIX	Sealing and bonding compound (66 ml)	

* © Schluter-Systems L.P., U.S. patent No. D593,641, other patents pending

Commercial Adaptor Kits - ABS Flange		
	Standard ABS bonding flange	Extended ABS bonding flange
4" (100 mm) Square Grate		
Tileable covering support (ECS)*	KDA/ABS/ECS	KDA/ABSL/ECS
Stainless steel (E)	KDA/ABS/E	KDA/ABSL/E
Oil-rubbed bronze stainless steel (EOB)	KDA/ABS/EOB	KDA/ABSL/EOB
Brushed brass anod. alu. (AMGB)	KDA/ABS/AMGB	KDA/ABSL/AMGB
Brushed copper anod. alu. (AKGB)	KDA/ABS/AKGB	KDA/ABSL/AKGB
Brushed nickel anod. alu. (ATGB)	KDA/ABS/ATGB	KDA/ABSL/ATGB
6" (150 mm) Square or Round Grate		
Square grate stainless steel (6E)	KDA/ABS/6E	KDA/ABSL/6E
Round grate stainless steel (6RE)	KDA/ABS/6RE	KDA/ABSL/6RE

* Patent pending

Flange and adaptor ring measurements - Commercial			
ABS			
		Standard	Extended
	A	11-13/16" - 300 mm	11-13/16" - 300 mm
	B	4-13/32" - 111.8 mm	4-13/32" - 111.8 mm
	C	4-11/16" - 118.9 mm	4-11/16" - 118.9 mm
	D	7-1/2" - 191 mm	7-1/2" - 191 mm
	E	5-7/64" - 130 mm	5-7/64" - 130 mm
	F	1-9/16" - 39.7 mm	3-1/16" - 77.8 mm
	G	2-9/64" - 54.3 mm	3-41/64" - 92.4 mm



DRAIN ADAPTOR KIT FOR USE WITH COMMERCIAL CLAMPING RING DRAINS - STAINLESS STEEL

Schluter®-KERDI-DRAIN with commercial adaptor ring and stainless steel flange			
	Includes	Description	Quantity
	1 KERDI-DRAIN	Drain with integrated bonding flange and grate assembly	1
	2 Adaptor ring*	For commercial clamping ring drains	
	3 KERDI-FIX	Sealing and bonding compound (66 ml)	

* © Schluter-Systems L.P., U.S. patent No. D593,641, other patents pending

Commercial Adaptor Kits - Stainless Steel Flange	
	Stainless steel bonding flange
4" (100 mm) Square Grate	
Tileable covering support (ECS)*	KDA/E/ECS
Stainless steel (E)	KDA/E/E
Oil-rubbed bronze stainless steel (EOB)	KDA/E/EOB
Brushed brass anod. alu. (AMGB)	KDA/E/AMGB
Brushed copper anod. alu. (AKGB)	KDA/E/AKGB
Brushed nickel anod. alu. (ATGB)	KDA/E/ATGB
6" (150 mm) Square or Round Grate	
Square grate stainless steel (6E)	KDA/E/6E
Round grate stainless steel (6RE)	KDA/E/6RE

* Patent pending

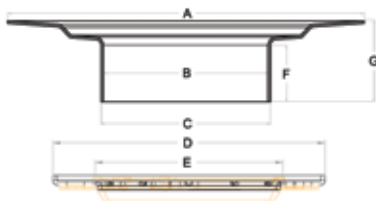
Flange and adaptor ring measurements - Commercial		
Stainless steel		
	A	9-27/32" - 250 mm
	B	4-9/16" - 115.7 mm
	C	4-11/16" - 118.7 mm
	D	7-1/2" - 191 mm
	E	5-7/64" - 130 mm
	F	1-9/16" - 39.7 mm
	G	2-3/16" - 56.5 mm

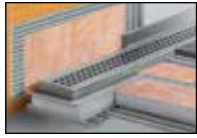

Note: There are multiple selections to be made for this product. Start by selecting the appropriate flange length then proceed to grate selection accordingly, keeping in mind there are two frame heights with two grate options (A or B), and a frameless option (D).

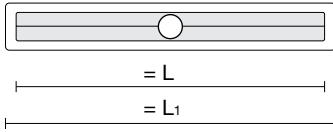

8.7 Schluter®-KERDI-LINE Bonding flange - stainless steel - center outlet

L = in. - cm	L ₁ = in. - cm	Item No.
19-11/16" - 50	21-11/16" - 55	KLV 60 E 50
23-5/8" - 60	25-5/8" - 65	KLV 60 E 60
27-9/16" - 70	29-9/16" - 75	KLV 60 E 70
31-1/2" - 80	33-1/2" - 85	KLV 60 E 80
35-7/16" - 90	37-7/16" - 95	KLV 60 E 90
39-3/8" - 100	41-3/8" - 105	KLV 60 E 100
43-5/16" - 110	45-5/16" - 115	KLV 60 E 110
47-1/4" - 120	49-1/4" - 125	KLV 60 E 120
51-3/16" - 130	53-3/16" - 135	KLV 60 E 130
55-1/8" - 140	57-1/8" - 145	KLV 60 E 140
59-1/16" - 150	61-1/16" - 155	KLV 60 E 150
62-15/16" - 160	64-15/16" - 165	KLV 60 E 160
66-7/8" - 170	68-7/8" - 175	KLV 60 E 170
70-13/16" - 180	72-13/16" - 185	KLV 60 E 180

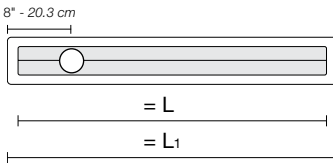

8.7 Schluter®-KERDI-LINE Bonding flange - stainless steel - off-set outlet

L = in. - cm	L ₁ = in. - cm	Item No.
27-9/16" - 70	29-9/16" - 75	KLVO 60 E 70
31-1/2" - 80	33-1/2" - 85	KLVO 60 E 80
35-7/16" - 90	37-7/16" - 95	KLVO 60 E 90
39-3/8" - 100	41-3/8" - 105	KLVO 60 E 100
43-5/16" - 110	45-5/16" - 115	KLVO 60 E 110
47-1/4" - 120	49-1/4" - 125	KLVO 60 E 120

Note : Please see page 19 for listings and certifications.

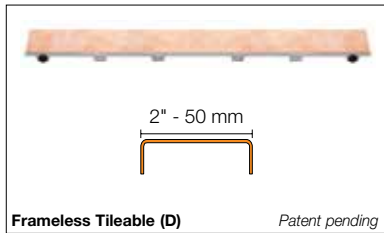
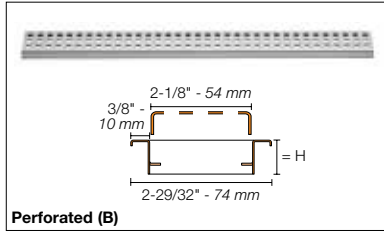
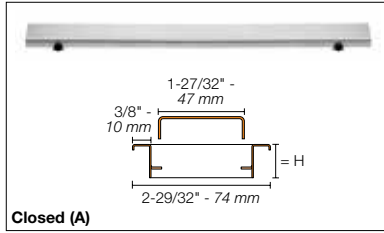

8.7 Schluter®-KERDI-LINE Grate assemblies

Length = in. - cm	Item No.		Item No.	
	Closed (A)	Perforated (B)	Frameless Tileable (D) - Patent pending	
			Center outlet	Off-set outlet
3/4" - 19 mm frame height for 1/8" to 9/16" - 3 mm to 15 mm -thick coverings				
19-11/16" - 50	KLAR 19 EB 50	KLB 19 EB 50	KLDRE 50	-
23-5/8" - 60	KLAR 19 EB 60	KLB 19 EB 60	KLDRE 60	-
27-9/16" - 70	KLAR 19 EB 70	KLB 19 EB 70	KLDRE 70	KLDRO E 70
31-1/2" - 80	KLAR 19 EB 80	KLB 19 EB 80	KLDRE 80	KLDRO E 80
35-7/16" - 90	KLAR 19 EB 90	KLB 19 EB 90	KLDRE 90	KLDRO E 90
39-3/8" - 100	KLAR 19 EB 100	KLB 19 EB 100	KLDRE 100	KLDRO E 100
43-5/16" - 110	KLAR 19 EB 110	KLB 19 EB 110	KLDRE 110	KLDRO E 110
47-1/4" - 120	KLAR 19 EB 120	KLB 19 EB 120	KLDRE 120	KLDRO E 120
51-3/16" - 130	KLAR 19 EB 130	KLB 19 EB 130	KLDRE 130	-
55-1/8" - 140	KLAR 19 EB 140	KLB 19 EB 140	KLDRE 140	-
59-1/16" - 150	KLAR 19 EB 150	KLB 19 EB 150	KLDRE 150	-
62-15/16" - 160	KLAR 19 EB 160	KLB 19 EB 160	KLDRE 160	-
66-7/8" - 170	KLAR 19 EB 170	KLB 19 EB 170	KLDRE 170	-
70-13/16" - 180	KLAR 19 EB 180	KLB 19 EB 180	KLDRE 180	-

Length = in. - cm	Item No.		Item No.	
	Closed (A)	Perforated (B)	Frameless Tileable (D) - Patent pending	
1-1/8" - 30 mm frame height for 1/2" to 1" - 13 mm to 25 mm -thick coverings				
19-11/16" - 50	KLAR 30 EB 50	KLB 30 EB 50		
23-5/8" - 60	KLAR 30 EB 60	KLB 30 EB 60		
27-9/16" - 70	KLAR 30 EB 70	KLB 30 EB 70		
31-1/2" - 80	KLAR 30 EB 80	KLB 30 EB 80		
35-7/16" - 90	KLAR 30 EB 90	KLB 30 EB 90		
39-3/8" - 100	KLAR 30 EB 100	KLB 30 EB 100		
43-5/16" - 110	KLAR 30 EB 110	KLB 30 EB 110		
47-1/4" - 120	KLAR 30 EB 120	KLB 30 EB 120		

Note: The perforated grate (B) is also available with a locking mechanism to prevent removal of the grate, for more information contact customer service at 1-800-472-4588 (US) or 1-800-667-8746 (CANADA).



14.1 Schluter®-SHOWERPROFILE-SA Two-part tapered edging profile

Item No.	H = in. - mm	H ₁ = in. - mm	H ₂ = in. - mm
L = 47-1/4" - 1.2 m			
SPSA 50 EB/120	3/16 - 5	1/4 - 6	1-3/16 - 30
L = 63" - 1.6 m			
SPSA 50 EB/160	3/16 - 5	1/4 - 6	1-1/2 - 38
L = 78-3/4" - 2 m			
SPSA 50 EB/200	3/16 - 5	1/4 - 6	1-13/16 - 46

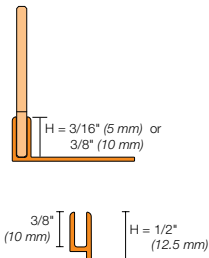

14.1 Schluter®-SHOWERPROFILE-SB Two-part tapered edging profile

Item No.	H = in. - mm	H ₁ = in. - mm	H ₂ = in. - mm
L = 47-1/4" - 1.2 m			
SPSB 100 EB/120	3/8 - 10	3/8 - 10	1-11/32 - 34
SPSB 125 EB/120	1/2 - 12.5	3/8 - 10	1-11/32 - 34
L = 63" - 1.6 m			
SPSB 100 EB/160	3/8 - 10	3/8 - 10	1-21/32 - 42
SPSB 125 EB/160	1/2 - 12.5	3/8 - 10	1-21/32 - 42
L = 78-3/4" - 2 m			
SPSB 100 EB/200	3/8 - 10	3/8 - 10	2 - 50
SPSB 125 EB/200	1/2 - 12.5	3/8 - 10	2 - 50

Note: Other sizes available. Contact Customer Service for price and availability.

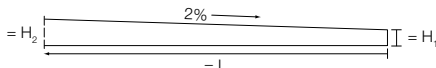



14.1 Schluter®-SHOWERPROFILE-R Two-part wall transition profile

Item No.	Height
L = 39" - 1 m	
SPRA 23 EB/100	29/32" - 1-3/8" (23 - 35 mm)
SPRA 33 EB/100	1-5/16" - 1-25/32" (33 - 45 mm)
L = 55" - 1.4 m	
SPRA 23 EB/140	29/32" - 1-3/8" (23 - 35 mm)
SPRA 33 EB/140	1-5/16" - 1-25/32" (33 - 45 mm)

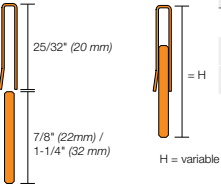

Note: When the SHOWERPROFILE-S/-R is not used with the Schluter®-Shower System the profile is covered under the Schluter®-Systems Wall and Countertop Profiles 5-Year Limited Warranty.



14.1 Schluter®-KERDI-LINE-FC Cover plate

Item No.	Width
V / KLEB 35	1-3/8" - 35 mm

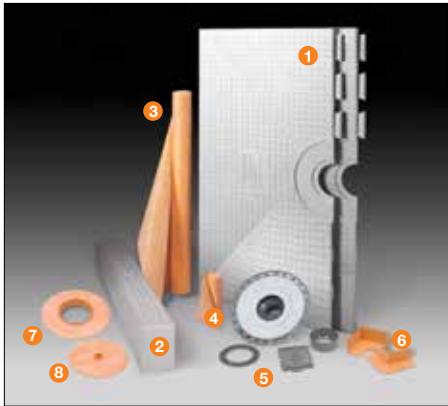
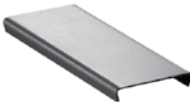
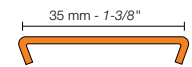

Schluter®-KERDI-SHOWER-KIT

Includes	Description	Quantity		
		48" x 48"	72" x 72"	32" x 60"
1 KERDI-SHOWER-ST	Shower Tray	1	1	1
2 KERDI-SHOWER-SC	Shower Curb 48" x 6" x 4-1/2"	1	2	2
3 KERDI 10 M	Waterproofing membrane 3' 3" x 33'			1
KERDI 12 M	Waterproofing membrane 3' 3" x 39' 4"	1		
KERDI 20 M	Waterproofing membrane 3' 3" x 65' 7"		1	
4 KERDI-BAND	Waterproofing strip 5" x 33'	1	2	1
5 KERDI-DRAIN	Drain, with integrated bonding flange with 2" (50 mm) outlet	1	1	1
6 KERDI-KERECK-F	Preformed waterproofing corners	4 inside and 2 outside		
7 KERDI-SEAL-PS	Pipe seal (3/4" - 20 mm)	1		
8 KERDI-SEAL-MV	Mixing valve seal	1		

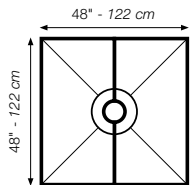

48" x 48" (122 x 122 cm) Kit

Item No.	Drain Material	Grate finish
KK122ABSECS	ABS	Tileable covering support
KK122ABSE	ABS	Stainless steel 304 (1.4301 = V2A)
KK122ABSEOB	ABS	Oil-rubbed bronze stainless steel
KK122ABSATGB	ABS	Brushed nickel anodized aluminum
KK122ABSAKGB	ABS	Brushed copper anod. alu.
KK122ABSAMGB	ABS	Brushed brass anodized aluminum
KK122PVCECS	PVC	Tileable covering support
KK122PVCE	PVC	Stainless steel 304 (1.4301 = V2A)
KK122PVCEOB	PVC	Oil-rubbed bronze stainless steel
KK122PVCATGB	PVC	Brushed nickel anodized aluminum
KK122PVCAKGB	PVC	Brushed copper anod. alu.
KK122PVCAMGB	PVC	Brushed brass anodized aluminum

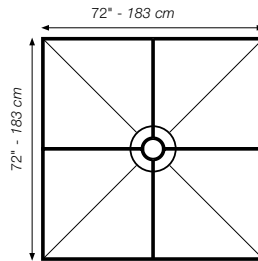

72" x 72" (183 x 183 cm) Kit

Item No.	Drain Material	Grate finish
KK183ABSECS	ABS	Tileable covering support
KK183ABSE	ABS	Stainless steel 304 (1.4301 = V2A)
KK183ABSEOB	ABS	Oil-rubbed bronze stainless steel
KK183ABSATGB	ABS	Brushed nickel anodized aluminum
KK183ABSAKGB	ABS	Brushed copper anod. alu.
KK183ABSAMGB	ABS	Brushed brass anodized aluminum
KK183PVCECS	PVC	Tileable covering support
KK183PVCE	PVC	Stainless steel 304 (1.4301 = V2A)
KK183PVCEOB	PVC	Oil-rubbed bronze stainless steel
KK183PVCATGB	PVC	Brushed nickel anodized aluminum
KK183PVCAKGB	PVC	Brushed copper anod. alu.
KK183PVCAMGB	PVC	Brushed brass anodized aluminum

SHOWER SYSTEM

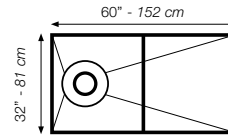
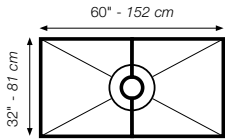

Note: Tray features off-center drain placement: 10" (25.4 cm) o.c. from end of tray.

32" x 60" (81 x 152 cm) Kit		
Item No.	Drain Material	Grate finish
KK81152ABSECS	ABS	Tileable covering support
KK81152ABSE	ABS	Stainless steel 304 (1.4301 = V2A)
KK81152ABSEOB	ABS	Oil-rubbed bronze stainless steel
KK81152ABSATGB	ABS	Brushed nickel anodized aluminum
KK81152ABSAKGB	ABS	Brushed copper anod. alu.
KK81152ABSAMGB	ABS	Brushed brass anodized aluminum
KK81152PVCECS	PVC	Tileable covering support
KK81152PVCE	PVC	Stainless steel 304 (1.4301 = V2A)
KK81152PVCEOB	PVC	Oil-rubbed bronze stainless steel
KK81152PVCATGB	PVC	Brushed nickel anodized aluminum
KK81152PVCAKGB	PVC	Brushed copper anod. alu.
KK81152PVCAMGB	PVC	Brushed brass anodized aluminum

32" x 60" (81 x 152 cm) Kit with off-center drain placement		
Item No.	Drain Material	Grate finish
KKB81152ABSECS	ABS	Tileable covering support
KKB81152ABSE	ABS	Stainless steel 304 (1.4301 = V2A)
KKB81152ABSEOB	ABS	Oil-rubbed bronze stainless steel
KKB81152ABSATGB	ABS	Brushed nickel anodized aluminum
KKB81152ABSAKGB	ABS	Brushed copper anod. alu.
KKB81152ABSAMGB	ABS	Brushed brass anodized aluminum
KKB81152PVCECS	PVC	Tileable covering support
KKB81152PVCE	PVC	Stainless steel 304 (1.4301 = V2A)
KKB81152PVCEOB	PVC	Oil-rubbed bronze stainless steel
KKB81152PVCATGB	PVC	Brushed nickel anodized aluminum
KKB81152PVCAKGB	PVC	Brushed copper anod. alu.
KKB81152PVCAMGB	PVC	Brushed brass anodized aluminum

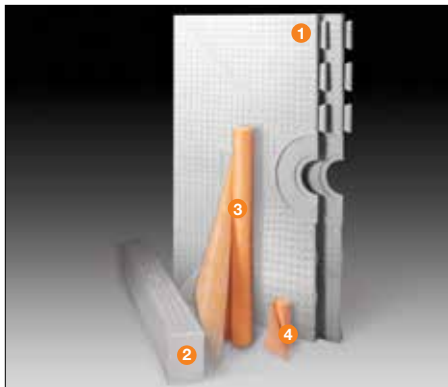

Schluter®-KERDI-SHOWER-KIT WITHOUT THE DRAIN				
Includes	Description	Quantity		
		48" x 48"	72" x 72"	32" x 60"
1	KERDI-SHOWER-ST Shower tray	1	1	1
2	KERDI-SHOWER-SC Shower curb 48" x 6" x 4-1/2"	1	2	2
3	KERDI 10 M Waterproofing membrane 3' 3" x 33'			1
	KERDI 12 M Waterproofing membrane 3' 3" x 39' 4"	1		
	KERDI 20 M Waterproofing membrane 3' 3" x 65' 7"		1	
4	KERDI-BAND Waterproofing strip 5" x 33'	1	2	1

Item No.	Tray size
KK122	48" x 48"
KK183	72" x 72"
KK81152	32" x 60"
KKB81152	32" x 60" off-center drain

Product Listings and Certifications Table

Schluter®-KERDI-DRAIN										
Bonding Flange 2" (50 mm) Outlet	Grate - 4" (100 mm)						Grate - 6" (150 mm)			
	E	EOB	AMGB	AKGB	ATGB	ECS*	6E	6RE	6CE	6RCE
ABS / PVC	1	-	1	1	1	1	1	1	2	2
Stainless steel	1	-	1	1	1	1	1	1	2	2
Bonding Flange 3" (75 mm) Outlet	Grate - 6" (150 mm)									
	6E		6RE		6CE		6RCE			
ABS / PVC	1		1		2		2			
Stainless steel	1		1		2		2			
Schluter®-KERDI-LINE										
Bonding Flange	Grate									
	A			B			D*			
Center outlet - 20" - 48" (50 cm - 120 cm)	1			1			1			
Center outlet - 52" - 72" (130 cm - 180 cm)	1			1			1			
Off-set outlet - 28" - 48" (70 cm - 120 cm)	1			1			1			

Various configurations of KERDI-DRAIN and KERDI-LINE are listed by UPC®, CSA, ICC-ES PMG, and NSF as shown in the table above.

1 - Listed by UPC®, CSA, NSF, and ICC-ES PMG

2 - Listed by CSA

* Patent pending

For copies of these documents, please contact Schluter®-Systems at 800-472-4588 (USA) or 800-667-8746 (Canada) or by email at info@schluter.com. Links to the documents can also be accessed at www.schluter.com.



A series of horizontal lines for writing, starting below the header and extending to the bottom of the page.



Schluter®-Shower System 10-Year Limited Warranty

COVERAGE AND CONDITIONS: Subject to the conditions and limitations as stated hereinafter, **Schluter-Systems*** warrants that the **Schluter®-Shower System** (the "Products")** will meet all composition and performance criteria for a period of ten (10) years from the date of purchase only when the Products are used and installed in accordance with the terms and conditions of the Schluter®-Shower System Installation Handbook and industry standard guidelines that are not in conflict with the Handbook in effect at the time of installation. Further, efflorescence is considered to be a natural occurrence with cementitious materials and is therefore not considered to be a defective condition and is not covered by this warranty. It is the responsibility of the owner/builder/installer to ensure the suitability of all building materials and all associated building materials for the owner's intended use. It is recommended that the owner consult with an experienced and professional installer.

RESOLUTION: If the Products fail to meet this warranty, then the owner's exclusive remedy and the sole obligation of Schluter-Systems, at its election, shall be to a) reinstall or replace the failed portion of the tile assembly or b) pay an amount not to exceed the original square foot cost of the installation of the tile assembly verified to be defective. Tile assembly is defined to include all Schluter®-KERDI products, non-reusable tile surfaces, and the appropriate setting and grouting materials. Further, due to conditions beyond the control of Schluter-Systems (e.g., color and shade availability, discontinuation, normal wear and tear), Schluter-Systems cannot guarantee or warrant an exact match to the specific tile, stone, or other covering materials used in the installation. In such events, substantially similar materials may be substituted.

DISCLAIMER: THERE ARE NO WARRANTIES BEYOND THIS EXPRESSED WARRANTY AS STATED ABOVE. ALL OTHER WARRANTIES, REPRESENTATIONS OR CONDITIONS, EXPRESSED OR IMPLIED, ARE DISCLAIMED AND EXCLUDED, INCLUDING WARRANTIES, REPRESENTATIONS OR CONDITIONS OF **MERCHANTABILITY** OR FITNESS FOR A PARTICULAR PURPOSE ARISING BY STATUTE OR OTHERWISE BY LAW OR FROM A COURSE OF DEALING OR USAGE OF TRADE. SCHLUTER-SYSTEMS EXCLUDES AND IN NO EVENT SHALL HAVE ANY LIABILITY FOR LOST PROFITS OR ANY OTHER INDIRECT, SPECIAL, INCIDENTAL, PUNITIVE, EXEMPLARY, OR CONSEQUENTIAL DAMAGES, ARISING OUT OF OR OTHERWISE CONNECTED TO FAILURE OF THE PRODUCTS, NOR MISUSE OF THE PRODUCTS OR FAILURE TO PROPERLY MAINTAIN THE SHOWER OR BATHTUB SURROUND. REGARDLESS OF ANY STRICT LIABILITY, ACTIVE OR PASSIVE NEGLIGENCE OF SCHLUTER-SYSTEMS, AND REGARDLESS OF THE LEGAL THEORY (CONTRACT OR TORT OR EXTRA-CONTRACTUAL OR OTHER), NOR FROM ACTS OF WAR, TERRORISM, FAULTY AND NEGLIGENT PENETRATION OF THE SYSTEM, FIRES, EXPLOSIONS, ACTS OF GOD, INTENTIONAL ACTS OF DESTRUCTION OR ANY LOSSES DUE TO STRUCTURAL FAILURE OR OTHER CAUSES UNRELATED TO THE PRODUCTS OR DELAYS, OR ANY OTHER INCIDENTAL OR CONSEQUENTIAL DAMAGES. THIS WARRANTY IS GIVEN IN LIEU OF ANY OTHER WARRANTY EXPRESSED OR IMPLIED. THE REMEDIES CONTAINED HEREIN ARE THE ONLY REMEDIES AVAILABLE FOR BREACH OF THIS WARRANTY. THIS LIMITED WARRANTY GIVES YOU SPECIFIC LEGAL RIGHTS; SOME STATES AND PROVINCES DO NOT ALLOW DISCLAIMERS OR OTHER RESTRICTIONS OF IMPLIED WARRANTIES, SO SOME OF THE ABOVE DISCLAIMERS MAY NOT APPLY TO YOU.

TRANSFERABILITY: This Limited Warranty extends ONLY to the original end user (defined as original intended owner and user of the property/unit in which the installation is incorporated - herein referred to as "Owner") and is not transferable or assignable, unless approved in writing by the Technical Director or an Officer of Schluter-Systems or otherwise prohibited by specific state or provincial law.

MODIFICATIONS TO WARRANTY: No changes or modification of any terms or conditions of this warranty are allowed unless authorized by written agreement and signed by the Technical Director or an Officer of Schluter-Systems.

EFFECTIVE DATE: This warranty shall supersede and replace any and all prior oral or written warranties, agreements, or other such representations made by or on behalf of Schluter-Systems relative to the Products or the application of the Products and shall apply to any installation occurring on or after January 1, 2013.

CLAIMS ON THIS LIMITED WARRANTY: To make a claim under this Limited Warranty, the Owner must provide Schluter-Systems with written notice within 30 days of any alleged defect in the Products covered by this Limited Warranty, together with date and proof of purchase of the Products, proof of the costs of the original installation and name and address of all installers, failing which this Limited Warranty shall be of no legal effect. Schluter-Systems reserves the right at its election and as a condition of this Limited Warranty to inspect the alleged failed and defective condition.

All U.S. Claims shall be sent to:

Schluter Systems L.P.
Attn: Warranty Claims Dept.
194 Pleasant Ridge Road
Plattsburgh, NY 12901-5841

All Canadian Claims shall be sent to:

Schluter Systems (Canada), Inc.
Attn: Warranty Claims Dept.
21100 chemin Ste-Marie
Ste-Anne-de-Bellevue, QC H9X 3Y8

*For the purpose of this warranty **Schluter Systems, L.P.** shall provide the warranty for all products for end users located in the United States, and **Schluter Systems (Canada) Inc.** shall provide the warranty for all products for end users located in Canada. This warranty is limited to sales of the Products made in and intended for use in the United States and Canada.

****Schluter®-Shower System (the "Products"):** The Products are defined to include all Schluter®-KERDI products referred to in the Handbook and used in the integrated Schluter®-Shower System.



Schluter Systems L.P. • 194 Pleasant Ridge Road, Plattsburgh, NY 12901-5841 • Tel.: 800-472-4588 • Fax: 800-477-9783
Schluter Systems (Canada) Inc. • 21100 chemin Ste-Marie, Ste-Anne-de-Bellevue, QC H9X 3Y8 • Tel.: 800-667-8746 • Fax: 877-667-2410

www.schluter.com