

FLOOR DRAINS



INNOVATIVE SOLUTIONS FOR CERAMIC AND STONE TILE

FLOOR DRAINS FOR BONDED WATERPROOF MEMBRANES

Schluter®-KERDI-DRAIN and Schluter®-KERDI-LINE floor drains provide a simple and secure connection to bonded waterproof membranes at the top of the assembly via an integrated bonding flange. Thus, the membrane is applied entirely at the surface, with all water directed into the top of the drain.

Application and Function

Schluter®-KERDI-DRAIN and Schluter®-KERDI-LINE are specifically designed for use in bonded waterproofing assemblies, such as showers, steam rooms, wet rooms, bathroom floors, commercial kitchen floors and other applications that require waterproofing and drainage.

8.2 Schluter®-KERDI-DRAIN is a floor drain specifically designed to allow connections to Schluter®-KERDI or other load-bearing, bonded waterproof membranes. The membrane is adhered to the large integrated bonding flange to form a waterproof connection at the top of the drain assembly. KERDI-DRAIN consists of a drain casing and fully adjustable grate assembly or covering support to which tile is applied. The grate assembly accommodates a wide range of tile thicknesses and allows lateral and tilt adjustment as well. The covering support is placed flush with the top of the bonding flange and can therefore accommodate any thickness tile covering.

The standard KERDI-DRAIN is attached directly to the waste line. The drain casing is available in ABS, PVC, or stainless steel. The plastic drain casings feature a fleece-covered bonding flange. They are available with standard 2" (50 mm) and 3" (75 mm) outlets and attached to the pipe using an appropriate solvent cement. The stainless steel drain casings are available

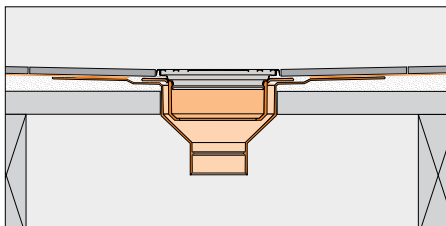

8.2 Schluter®-KERDI-DRAIN

with standard 2" (50 mm) and 3" (75 mm) no-hub outlets and 2" (50 mm) threaded outlet. The no-hub outlets are attached to the pipe using an appropriate mechanical (e.g., flexible or no-hub) coupling. The threaded outlets are attached to the pipe using thread sealing compound or tape. The simple connection to standard drain outlets makes KERDI-DRAIN suitable for new construction and renovation.

The KERDI-DRAIN adaptor kit is designed to convert clamping ring drains by equipping them with an integrated bonding flange. The adaptor kit includes a stainless steel adaptor ring with an over-molded rubber gasket and a variety of perforated hole patterns that align with most common clamping ring shower drains. The adaptor ring replaces the clamping ring and is attached to the drain body using the clamping ring bolts.

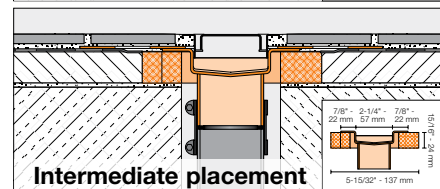
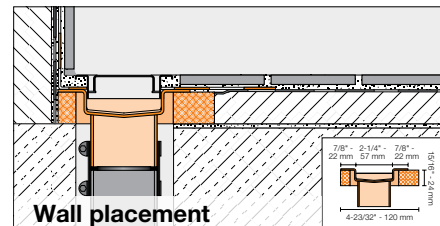
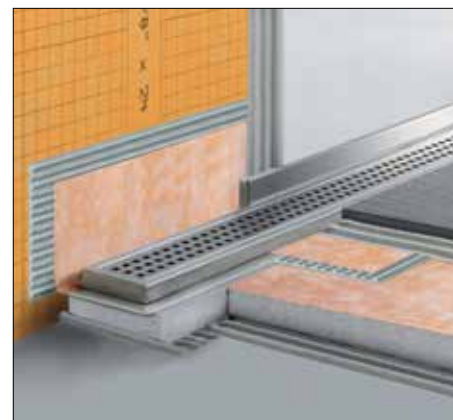

8.7 Schluter®-KERDI-LINE

This connection is made watertight via the rubber gasket and Schluter®-KERDI-FIX adhesive/sealant. The integrated bonding flange slides into the adaptor ring, with the over-molded rubber gasket ensuring a watertight seal. Commercial KERDI-DRAIN adaptor kits feature a 7-1/2" (191 mm) diameter adaptor ring and are available with a stainless steel bonding flange or an ABS bonding flange. The ABS bonding flange is available in two sizes (standard or extended length) to accommodate different tile assembly thicknesses. The residential KERDI-DRAIN adaptor kit features a

5-1/4" (133 mm) diameter adaptor ring and an ABS bonding flange. The KERDI-DRAIN adaptor kit is particularly useful in renovations where the clamping ring drains are difficult to replace with the standard KERDI-DRAIN (e.g., when they are set in concrete slabs).

The grate assembly consists of a height adjustment collar, lateral adjustment ring, and drain grate or covering support. The grates are installed in conjunction with a height adjustment collar and lateral adjustment ring, which are made of ABS or stainless steel, to allow for simple and convenient adjustment when setting the tile. Drain grates are available in stainless steel with a polished or oil-rubbed bronze finish and in anodized aluminum with a brushed copper bronze, brushed brass, or brushed nickel finish. The polished stainless steel grates are available in 4" (100 mm) -square, 6" (150 mm) -square and -round versions. All other grates are available in the 4" (100 mm) -square version only. Please note that grate assemblies included with the plastic KERDI-DRAIN featuring 3" (75 mm) outlets and the residential adaptor kits only allow vertical and tilt adjustment (no lateral adjustment). The covering support is a 4" (100 mm) -square stainless steel plate with KERDI laminated on the surface to allow for bonding of ceramic or stone tile, which creates a virtually invisible drainage line.

8.7 Schluter®-KERDI-LINE is a low profile linear floor drain specifically designed for bonded waterproofing assemblies. KERDI-LINE can be installed adjacent to walls or at intermediate locations. The floor can be sloped on a single plane to KERDI-LINE, which enables the use of large-format tiles and creates interesting design opportunities.

KERDI-LINE consists of a formed stainless steel channel body and grate assembly or covering support to which tile is applied. The channel body features a standard 2" (50 mm) no-hub outlet and is attached to the pipe using an appropriate mechanical no-hub coupling. The simple connection to standard drain outlets makes KERDI-LINE suitable for new construction and renovation. KERDI-LINE is available with both center and off-set outlets. The off-set outlet is located 8" (20.3 cm) from the edge of the channel body and provides flexibility when obstacles (e.g., floor joists) are encountered during installation. The grate assembly can be seamlessly adjusted

to the thickness of the ceramic tile or stone covering from 1/8" to 1" (3 to 25 mm). The covering support is placed flush with the top of the channel body and can therefore accommodate any thickness tile covering. KERDI-LINE includes a corresponding polystyrene foam channel support. The perimeter of the channel body consists of a bonding flange laminated with a collar made of KERDI. It ensures a simple and secure connection to the bonded waterproofing assembly, both in the floor area and on adjacent walls.

The grate assembly consists of a brushed stainless steel frame and two design grate options. Option A is a closed-design, brushed stainless steel grate. Option B is a brushed stainless grate with square perforations. Option B is also available with a locking mechanism (3/4" - 19 mm frame only) for applications where tamper resistance is desired or required (e.g., healthcare and education facilities, etc.). The covering support D is a stainless steel plate with KERDI laminated on the surface to allow for bonding of ceramic or stone tile, which creates a virtually invisible drainage line. KERDI-LINE is available in channel lengths from 20" to 72" (50 to 180 cm) in 4" (10 cm) increments. Please note that the bonding flange extends approximately 1" (2.5 cm) beyond the channel on all sides.

Schluter®-KERDI-LINE-FC is a stainless steel cover plate for use with KERDI-LINE to create a seamless look in applications where multiple drains are installed end-to-end. KERDI-LINE-FC features a brushed finish, and is designed for use with either the solid or perforated grates with brushed stainless steel frame.

Material Properties and Areas of Application

KERDI-DRAIN drain casings are formed using ABS, PVC, or stainless steel 304 (1.4301 = V2A). Plastic drain casings feature a polypropylene fleece webbing. The KERDI-DRAIN adaptor kits feature adaptor rings made of stainless steel 304 (1.4301 = V2A) with thermoplastic rubber gaskets and adaptor flanges made of stainless steel 304 (1.4301 = V2A) or ABS. Drain grates are available in stainless steel 304 (1.4301 = V2A) and anodized aluminum. The covering support is stainless steel 304 (1.4301 = V2A) with KERDI laminated on the surface.

The KERDI-LINE channel body is formed using stainless steel 316 L (1.4404 = V4A) and features a bonding flange with a KERDI collar laminated on the surface. KERDI is a bonded waterproof membrane made of soft polyethylene, which is covered on both sides with a special fleece webbing to anchor the membrane in the thin-set mortar. The frame and grates are made of stainless steel 316 L (1.4404 = V4A). The channel support is made of pressure-resistant, expanded polystyrene (EPS).

KERDI-DRAIN and KERDI-LINE are suitable for use in residential and commercial applications, including areas subject to foot and wheelchair traffic, such as showers and wet rooms in homes, hotels, schools, healthcare facilities, etc.

The KERDI-LINE-FC is roll-formed using stainless steel 316 L (1.4404 = V4A).

Stainless steel can sustain high mechanical stresses and is particularly suitable for applications requiring resistance against chemicals and acids. However, even stainless steel is not resistant to all chemical stresses, and may be affected by hydrochloric and hydrofluoric acid or certain chlorine, chloride and brine concentrations, which may be present in detergents or swimming pools. In special cases, the suitability of the selected floor drainage system must be verified based on the anticipated chemical, mechanical, and/or other stresses.

Anodized aluminum retains a uniform appearance during normal use. The surface, however, is susceptible to scratching and wear and may be damaged by grout or setting material. Therefore, these materials must be removed immediately.

Various configurations of KERDI-DRAIN and KERDI-LINE are listed by UPC®, CSA, NSF and ICC-ES PMG.

Note: Product listings and certifications can be referenced on page 14.

Installation

The installation instructions below represent the use of KERDI-DRAIN and KERDI-LINE in floor applications. Installation instructions for the use of KERDI-DRAIN and KERDI-LINE in shower applications can be found in the Schluter®-Shower System Installation Handbook.

KERDI-DRAIN

Preparation

After locating the correct position, cut a hole in the substrate for the drain outlet and coupling to the waste line using the template provided. Note: Fill in box-outs in concrete floors with dry-pack mortar. A pipe coupling or similar can be used as a form around the waste line. Select form to accommodate the drain outlet and mechanical no-hub coupling (when applicable). Limit the diameter of the hole to 5" (125 mm) maximum to ensure proper support of the tile assembly. A larger hole can lead to lack of support and damage the tile assembly (e.g., cracked grout around drain).

Drain installation

Access to plumbing from below

If there is access to the plumbing from below and the waste line can be connected after installing KERDI-DRAIN, the drain can be installed in conjunction with the mortar bed.

- Place a ring of loose mortar up to the inlet hole in the floor and firmly press the drain into the mortar. The bonding flange must be fully supported to prevent damage to the tile assembly (e.g., cracked grout around drain). When installing KERDI-DRAIN over wood substrates, the minimum thickness of mortar required at the perimeter of the bonding flange is 1" (25 mm).
- The screed is then placed flush with the top of the bonding flange of the KERDI-DRAIN. Slope the mortar bed using the bonding flange and mortar screeds as guides.

No access to plumbing from below

When there is no access to the plumbing from below, install the KERDI-DRAIN to the appropriate height prior to the installation of the shower base.

- Begin the drain installation by dry fitting the components. Measure and cut a section of pipe to connect the KERDI-DRAIN to the odor trap below the floor, using the foam spacers included with the drain as a spacer. When installing KERDI-DRAIN over wood substrates, the minimum thickness of mortar required at the perimeter of the bonding flange is 1" (25 mm).
- Prepare the odor trap, cut section of pipe, and KERDI-DRAIN with cleaner, primer and ABS or PVC cement per the solvent cement manufacturer's instructions and connect.
- Pack loose mortar under the drain up to the inlet hole to ensure solid and uniform support of the bonding flange. The screed is then placed flush with the top of the bonding flange of the KERDI-DRAIN. Slope the mortar bed using the bonding flange and mortar screeds as guides.

Clamping ring drain already installed

If a clamping ring drain is already installed, the drain must be replaced with KERDI-DRAIN or converted using the KERDI-DRAIN adaptor kit.

- If using the KERDI-DRAIN adaptor kit, remove the clamping ring from the installed drain and save the bolts for installation of the adaptor ring. Align the bolt pattern of the clamping ring with the matching punch-outs in the adaptor ring. Punch the matching inserts out through the stainless steel adaptor ring.
- Apply a continuous 1/4" - 3/8" (6 - 10 mm) bead of KERDI-FIX to the underside of the adaptor ring. Align the holes in the adaptor ring with the bolt holes in the installed drain and place the adaptor ring on the installed drain flange. Re-insert and tighten the bolts using a star pattern. Bolts are to be finger-tight plus 1/4 turn; do not overtighten, as this may warp the adaptor ring and result in leaks.
- Slide the adaptor flange into the adaptor ring and ensure full support under the adaptor flange with mortar. The screed is then placed flush with the top of the bonding flange of the KERDI-DRAIN. Slope the mortar bed using the bonding flange and mortar screeds as guides.

Note: Schluter®-Systems recommends a leak test be performed on the connection between the drain and the waste line prior to continuing with the remainder of the

installation whenever possible.

Connection to waterproofing membranes

The KERDI or DITRA waterproofing membranes can be installed over the mortar bed as soon as it can be walked upon.

KERDI

- Apply unmodified thin-set mortar to the bonding flange and surrounding mortar bed with a 1/4" x 3/16" (6 x 5 mm) V-notched trowel or the KERDI-TROWEL, which features a 1/8" x 1/8" (3 x 3 mm) square-notched design. The thin-set mortar must be mixed to a fairly fluid consistency, but still able to hold a notch.

Note: When using the stainless steel bonding flange, the membrane is bonded to the integrated bonding flange with KERDI-FIX adhesive/sealant. The stainless steel bonding flange must be clean and free of grease or other contaminants prior to KERDI-FIX application.

- Embed KERDI in the bond coat and work the membrane onto the KERDI-DRAIN bonding flange and mortar bed with the flat side of the trowel to ensure full coverage and remove air pockets. The membrane is carried to the step in the bonding flange (template provided).

DITRA or DITRA-XL

- DITRA or DITRA-XL is installed up to the outer edge of the KERDI-DRAIN bonding flange. Apply unmodified thin-set mortar to the mortar bed surrounding KERDI-DRAIN with a 1/4" x 3/16" (6 x 5 mm) V-notched trowel or the DITRA-TROWEL, which features an 11/64" x 11/64" (4.5 x 4.5 mm) square-notched design. The thin-set mortar must be mixed to a fairly fluid consistency, but still able to hold a notch. Solidly embed the matting into the bond coat using a float, screed trowel, or DITRA-ROLLER.
- DITRA or DITRA-XL is sealed to the KERDI-DRAIN bonding flange using a cut section of the KERDI membrane. Apply unmodified thin-set mortar to the bonding flange and surrounding membrane with a 1/4" x 3/16" (6x5mm) V-notched trowel or the KERDI-TROWEL, which features a 1/8" x 1/8" (3 x 3 mm) square-notched design.



- Note:** When using the stainless steel bonding flange, the KERDI is bonded to the integrated bonding flange with KERDI-FIX adhesive/sealant. The stainless steel bonding flange must be clean and free of grease or other contaminants prior to KERDI-FIX application.
- Embed a 20" x 20" (50 x 50 cm) cut section of KERDI in the bond coat and work the membrane onto the KERDI-DRAIN bonding flange and surrounding membrane to ensure full coverage and remove air pockets. The KERDI is carried to the step in the bonding flange (template provided) and must overlap the DITRA or DITRA-XL membrane by a minimum of 2" (50 mm).

Grate assembly

Grate

- The grate assembly is installed in conjunction with the tile. Place the height adjustment collar inside the lateral adjustment ring and snap the grate into place.

Note: For drains with 6" (150 mm) grates, the height adjustment collar is integrated with the grate. For the residential adaptor kit, there is no lateral adjustment ring.
- Fill the step in the bonding flange with unmodified thin-set mortar and back-butter the underside of the grate to ensure full support. Press the assembly into the mortar and install the surrounding tiles, ensuring full coverage.
- Position the grate to match the joint pattern of the tile covering and press flush with the tile surface. Remove all excess setting material.

Note: Protect the visible surface of the grate from contact with setting and grouting materials. In particular, anodized aluminum is sensitive to alkaline materials.

Tileable Covering Support

- The covering support is installed in conjunction with the tile. Place the tile spacer inside the lateral adjustment ring.
- Fill the step in the bonding flange with thin-set mortar and press the assembly into the mortar. Install the surrounding tiles up to the tile spacer using unmodified thin-set mortar, ensuring full coverage. Set the tile to the integrated tabs on the lateral adjustment ring,

which provide for a flush transition to the covering support. Remove all excess setting material. Position the tile spacer to match the joint pattern of the tile covering.

- Apply tile to the top of the covering support using unmodified thin-set mortar. The tile is installed flush with all sides of the covering support to provide the drainage openings.
- Once the assembly has been set and grouted, remove the tile spacer and insert the tiled covering support in the lateral adjustment ring.

Note: For acid-resistant coverings, use an epoxy adhesive to set and grout the tile.

KERDI-LINE

Preparation

- Any leveling of the floor must be done prior to the installation of the channel body. For installation adjacent to the wall, the channel body must be aligned in accordance with the thickness of the wall covering. For intermediate installation, use the supplied filling strip with peel-and-stick adhesive layer to make the channel support symmetrical.
- KERDI-LINE can be installed in conjunction with the provided channel support as described below or set in loose mortar. KERDI-LINE is connected to the waste line with the appropriate mechanical no-hub coupling in accordance with the coupling manufacturer's instructions.

Channel body installation

Access to plumbing from below

When there is access to the plumbing from below and the waste line can be connected after installing KERDI-LINE, the channel body may be set without making a connection to the waste line simultaneously.

- Apply unmodified thin-set mortar to the substrate where the drain is to be placed with a notched trowel and solidly embed the channel support in the mortar.
- Apply unmodified thin-set mortar to the top of the channel support with a notched trowel and press the channel body firmly into the mortar, ensuring full support of the bonding flange. Check to make sure the KERDI-LINE is level.

No access to plumbing from below

When there is no access to the plumbing from below, the channel body must be set and connected to the waste line simultaneously.

- Begin the drain installation by dry fitting the components. Measure and cut a section of pipe to connect the coupling to the odor trap below the floor, using the channel support as a spacer.
- Apply unmodified thin-set mortar to the top of the channel support with a notched trowel and press the channel support firmly onto the underside of the channel body. Attach the mechanical coupling to the drain outlet and the cut section of the pipe per the coupling manufacturer's instructions.
- Apply unmodified thin-set mortar to the substrate where the drain is to be placed with a notched trowel. Prepare the cut section of pipe and odor trap with cleaner, primer and ABS or PVC cement per the solvent cement manufacturer's instructions.
- Solidly embed the channel support and KERDI-LINE into the mortar on the floor and connect the cut section of pipe to the odor trap. Check to make sure the KERDI-LINE is level.
- The screed is then placed flush with the top of the bonding flange of the KERDI-LINE. Slope the mortar bed using the bonding flange and mortar screeds as guides.

Note: KERDI-FIX or other adhesives that are compatible with EPS foam can be used to install the channel support and channel body as an alternative to thin-set mortar. Apply a generous bead of KERDI-FIX to the top and bottom of the channel support. The use of KERDI-FIX limits the ability to level KERDI-LINE.

Note: Schluter®-Systems recommends a leak test be performed on the connection between the drain and the waste line prior to continuing with the remainder of the installation whenever possible.

Connection to waterproofing membranes

The KERDI or DITRA waterproofing membranes can be installed as soon as the mortar bed can be walked upon.

- KERDI, DITRA or DITRA-XL is installed up to the outer edge of the KERDI-LINE bonding flange using unmodified thin-set mortar. The thin-set mortar must be mixed to a fairly fluid consistency, but



still able to hold a notch.

- KERDI:** Apply unmodified thin-set mortar to the mortar bed surrounding KERDI-LINE with a 1/4" x 3/16" (6 x 5 mm) V-notched trowel or the KERDI-TROWEL, which features a 1/8" x 1/8" (3 x 3 mm) square-notched design. Embed KERDI in the bond coat with the flat side of the trowel to ensure full coverage and remove air pockets.
 - DITRA:** Apply unmodified thin-set mortar to the mortar bed surrounding KERDI-LINE with a 1/4" x 3/16" (6 x 5 mm) V-notched trowel or the DITRA-TROWEL, which features an 11/64" x 11/64" (4.5 x 4.5 mm) square-notched design. Solidly embed the matting into the bond coat using a float, screed trowel, or DITRA-ROLLER.
- Apply unmodified thin-set mortar to the membrane surrounding KERDI-LINE with a 1/4" x 3/16" (6 x 5 mm) V-notched trowel or the KERDI-TROWEL, which features a 1/8" x 1/8" (3 x 3 mm) square-notched design. Embed the KERDI collar in the bond coat to ensure full coverage and remove air pockets.

Grate assembly

Grate A and B

- Apply unmodified thin-set mortar to the underside of the grate frame and place it in the channel body ensuring full coverage and support of the frame. Insert the foam spacers in the grate frame to reinforce it during the remainder of the installation.

Note: The tape on the grate frame does not need to be removed. It is intended to help keep setting material out of the channel body during installation.
- Insert the plastic height adjustment spacers with threaded bolts under the tabs along the inside of the grate frame to adjust the elevation of the frame such that the surface of the frame will be flush with the surface of the tile covering. The spacers may be adjusted simply by turning the bolts by hand.
- Apply unmodified thin-set mortar to the substrate and install the tiles, ensuring full coverage. Once the tile covering is set and grouted, remove the spacers from the grate frame and insert the grate.

Note: Protect the visible surfaces of the grate frame and grate from contact with setting and grouting materials. Setting and grouting materials must be removed immediately.

KERDI-LINE-FC

- Install KERDI-LINE channel bodies end-to-end and overlap the KERDI collars using unmodified thin-set mortar to ensure a waterproof connection. KERDI-LINE-FC is subsequently installed in conjunction with the KERDI-LINE grate assembly and adjacent tiles.

Note: KERDI-LINE-FC may be used with tiles that are 1/4" (6 mm) thick or greater.
- Apply a sufficient amount of thin-set mortar to the substrate and/or the back of KERDI-LINE-FC and press the profile into the mortar until its surface is flush with the adjacent tile and grate assembly.
- Leave a space of approximately 1/16" – 1/8" (1.5 – 3 mm).
- Fill the joints completely with grout or setting material.

Grate D

Wall Installation

- Peel protective foil off the cover strip and adhere the strip to the bonding flange adjacent to the wall(s). Position the strip along the edge of the channel. The cover strip hides and protects the KERDI surface under the tile.
- Insert the tile spacers into the channel body. Install the surrounding tile on the adjoining walls and mortar bed up to the spacers using unmodified thin-set mortar, ensuring full coverage. Remove all excess setting material.
- Apply tile to the top of the covering support using unmodified thin-set mortar. The tile is installed flush with the front side of the covering support to provide the drainage opening and overhanging the back side of the covering support to cover the bonding flange along the wall. Measure and cut the tile such that an approximate 1/16" (1 mm) gap is left at the wall. When the ends of the channel body are located adjacent to walls, the tile is installed overhanging the end of the plate to cover the bonding flange along the walls. Measure and cut the tile such that an approximate 1/16" (1 mm) gap is left at the walls.

Note: When the mortar bed is tiled beyond the ends of the channel, the tile on the ends of the covering support can be cut to either match the grout joints of the surrounding floor covering or to provide a perimeter drainage opening.

Intermediate Installation

- When the ends of the channel body are located adjacent to walls, peel protective foil off the cover strip and adhere the strip to the bonding flange adjacent to the walls. Position the strip along the edge of the channel. The cover strip hides and protects the KERDI surface under the tile. When the mortar bed will be tiled beyond the ends of the channel, the cover strip is not required.
- Insert the tile spacers into the channel body. Install the surrounding tile on the adjoining walls (if applicable) and mortar bed up to the spacers using unmodified thin-set mortar, ensuring full coverage. Remove all excess setting material.
- Apply tile to the top of the covering support using thin-set mortar. The tile is installed flush with the front and back of the covering support to provide the drainage openings. When the ends of the channel body are located adjacent to walls, the tile is installed overhanging the end of the plate to cover the bonding flange along the wall. Measure and cut the tile such that an approximate 1/16" (1 mm) gap is left at the wall.

Note: When the mortar bed is tiled beyond the ends of the channel, the tile on the ends of the covering support can be cut to either match the grout joints of the surrounding floor covering or to provide perimeter drainage openings.

Note: For acid-resistant coverings, use an epoxy adhesive to set and grout the tile.

Maintenance

KERDI-DRAIN and KERDI-LINE require no special maintenance and are resistant to mold and fungi. The grate may be removed to clean the drain housing and the drain pipes.

Clean the grates and profiles using common household cleaning agents. Stainless steel exposed to the environment or aggressive substances should be cleaned periodically using a mild household cleaner. Regular cleaning maintains the neat appearance of stainless steel and reduces the risk of corrosion. All cleaning agents must be free of hydrochloric acid, hydrofluoric acid, and chlorides. Stainless steel surfaces develop a sheen when treated with a chrome-polishing agent. Do not use abrasive or alkaline cleaning agents.

Product Item Numbers

8.2 Schluter®-KERDI-DRAIN



4" Grate Options		
Tileable Covering Support	Anodized Aluminum	Stainless Steel
<p>(ECS) Patent pending</p>	<p>Brushed nickel (ATGB)</p> <p>Brushed copper/bronze (AKGB)</p> <p>Brushed brass (AMGB)</p>	<p>Oil-rubbed bronze (EOB)</p> <p>Stainless steel (E)</p>

6" Grate Options	
Stainless Steel	Stainless Steel Cover for Cleanout Applications
<p>(6E)</p> <p>(6RE)</p>	<p>(6CE)</p> <p>(6RCE)</p>

Flange Options			
ABS - 2" or 3" Outlet	PVC - 2" or 3" Outlet	Stainless Steel - 2" or 3" No-hub Outlet	Stainless Steel - 2" Threaded Outlet

Note: Product listings and certifications can be referenced on page 14.

DRAIN KITS - ABS or PVC FLANGE - 2" OR 3" OUTLET

Schluter®-KERDI-DRAIN - Components - ABS or PVC Flange

	Includes	Description	Quantity
	1 KERDI-DRAIN	Drain with integrated bonding flange and grate assembly	1
	2 KERDI-KERECK-F	Preformed waterproofing corners	4 inside and 2 outside
	3 KERDI-SEAL-PS	Pipe seal (3/4" - 20 mm)	1
	4 KERDI-SEAL-MV	Mixing valve seal	1





2" Drain Outlet		
	ABS flange	PVC flange
4" (100 mm) Square Grate		
Tileable covering support (ECS)*	KD2/ABS/ECS ¹	KD2/PVC/ECS ¹
Stainless steel (E)	KD2/ABS/E ¹	KD2/PVC/E ¹
Oil-rubbed bronze stainless steel (EOB)	KD2/ABS/EOB	KD2/PVC/EOB
Brushed brass anod. alu. (AMGB)	KD2/ABS/AMGB ¹	KD2/PVC/AMGB ¹
Brushed copper/bronze anod. alu. (AKGB)	KD2/ABS/AKGB ¹	KD2/PVC/AKGB ¹
Brushed nickel anod. alu. (ATGB)	KD2/ABS/ATGB ¹	KD2/PVC/ATGB ¹
6" (150 mm) Square or Round Grate		
Square grate stainless steel (6E)	KD2/ABS/6E ¹	KD2/PVC/6E ¹
Round grate stainless steel (6RE)	KD2/ABS/6RE ¹	KD2/PVC/6RE ¹

3" Drain Outlet		
	ABS flange	PVC flange
6" (150 mm) Square or Round Grate		
Square grate stainless steel (6E)	KD3/ABS/6E ¹	KD3/PVC/6E ¹
Round grate stainless steel (6RE)	KD3/ABS/6RE ¹	KD3/PVC/6RE ¹

¹ Listed by ICC-ES (Report No. PMG-1204), UPC®, CSA, and NSF
* Patent pending

Flange Measurements			
ABS or PVC			
		2" (50 mm) drain outlet	3" (75 mm) drain outlet
	A	11-13/16" - 300 mm	11-13/16" - 300 mm
	B	4-17/32" - 115.2 mm	4-17/32" - 115.2 mm
	C	2-45/64" - 68.6 mm	3-15/16" - 100 mm
	D	2-3/8" - 60.5 mm	3-1/2" - 88.8 mm
	E	3-15/16" - 100 mm	3-15/16" - 100 mm
	F	1-39/64" - 40.6 mm	2" - 50.8 mm
	G	7/8" - 22.5 mm	1-1/2" - 38.1 mm

DRAIN KITS - STAINLESS STEEL FLANGE - 2" OR 3" NO-HUB OUTLET

Schluter®-KERDI-DRAIN - Components - Stainless Steel Flange			
Includes	Description	Quantity	
	1 KERDI-DRAIN	Drain with integrated bonding flange and grate assembly	1
	2 KERDI-KERECK-F	Preformed waterproofing corners	4 inside and 2 outside
	3 KERDI-SEAL-PS	Pipe seal (3/4" - 20 mm)	1
	4 KERDI-SEAL-MV	Mixing valve seal	1
	5 KERDI-FIX	Sealing and bonding compound (66 ml)	1

2" No-hub Outlet	
	Stainless steel flange
4" (100 mm) Square Grate	
Tileable covering support (ECS)*	KD2/E/ECS ¹
Stainless steel (E)	KD2/E/E ¹
Oil-rubbed bronze stainless steel (EOB)	KD2/E/EOB
Brushed brass anod. alu. (AMGB)	KD2/E/AMGB ¹
Brushed copper/ bronze anod. alu. (AKGB)	KD2/E/AKGB ¹
Brushed nickel anod. alu. (ATGB)	KD2/E/ATGB ¹
6" (150 mm) Square or Round Grate	
Square grate stainless steel (6E)	KD2/E/6E ¹
Round grate stainless steel (6RE)	KD2/E/6RE ¹

3" No-hub Outlet	
	Stainless steel flange
6" (150 mm) Square or Round Grate	
Square grate stainless steel (6E)	KD3/E/6E ¹
Round grate stainless steel (6RE)	KD3/E/6RE ¹

¹ Listed by ICC-ES (Report No. PMG-1204), UPC®, CSA, and NSF
* Patent pending

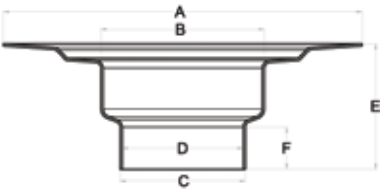
Flange Measurements			
Stainless steel			
		2" (50 mm) no-hub outlet	3" (75 mm) no-hub outlet
	A	9-27/32" - 250 mm	9-27/32" - 250 mm
	B	4-1/2" - 115.4 mm	4-1/2" - 114 mm
	C	2-13/32" - 61.3 mm	3-7/16" - 87.4 mm
	D	2-13/32" - 60.6 mm	3-5/16" - 84.2 mm
	E	3-11/32" - 85 mm	3-7/16" - 87.4 mm
	F	53/64" - 21 mm	1-5/32" - 29.4 mm

GRATE & FLANGE KITS (sold separately)

Grate Kit - Components		
		Patent pending
		
Includes	Description	Quantity
1a 1b Grate Assembly	a) For stainless steel and aluminum grates b) For tileable covering support	1
2 KERDI-KERECK-F	Preformed waterproofing corners	4 inside and 2 outside
3 KERDI-SEAL-PS	Pipe seal (3/4" - 20 mm)	1
4 KERDI-SEAL-MV	Mixing valve seal	1

Grate Kits	
Finish	Item No.
4" (100 mm) Square Grate	
Tileable covering support (ECS)*	KD2/ECS/GR
Stainless steel (E)	KD2/E/GR
Oil-rubbed bronze stainless steel (EOB)	KD2/EOB/GR
Brushed brass anod. alu. (AMGB)	KD2/AMGB/GR
Brushed copper/ bronze anod. alu. (AKGB)	KD2/AKGB/GR
Brushed nickel anod. alu. (ATGB)	KD2/ATGB/GR
Stainless steel (E) with stainless steel height adjustment collar and lateral adjustment ring	KD2/E/E/GR
6" (150 mm) Square or Round Grate	
Square grate stainless steel (6E)	KD2/6E/GR
Round grate stainless steel (6RE)	KD2/6RE/GR
6" (150 mm) Square or Round Cover	
Square cover stainless steel (6CE)	KD-GR6C-E
Round cover stainless steel (6RCE)	KD-GR6RC-E

Note: 6" square and round covers do not include the seals and corners.
* Patent pending

Flange Kit - Components	
	
Includes	Quantity
Drain with integrated bonding flange	1

Flange Kits	
Material	Item No.
2" (50 mm) Drain Outlet	
ABS	KD2/ABS/FL
PVC	KD2/PVC/FL
Stainless Steel with no-hub outlet	KD2/E/FL
Stainless Steel with threaded outlet	KD2/ETH/FL
3" (75 mm) Drain Outlet	
ABS	KD3/ABS/FL
PVC	KD3/PVC/FL
Stainless Steel with no-hub outlet	KD3/E/FL

i Please note that flanges with 3" outlets are intended for use with 6" grates as these combinations have listings and certifications while flanges with 3" outlet combined with 4" grates do not. Please refer to the Listings and Certifications table on page 14.

DRAIN ADAPTOR KIT FOR USE WITH RESIDENTIAL CLAMPING RING DRAINS - ABS

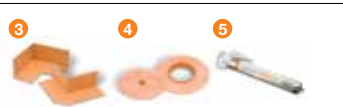
Schluter®-KERDI-DRAIN with residential adaptor ring and ABS flange			
Includes	Description	Quantity	
	1 KERDI-DRAIN	Drain with integrated bonding flange and grate assembly	1
	2 Adaptor ring*	For residential clamping ring drains	1
	3 KERDI-KERECK-F	Preformed waterproofing corners	4 inside and 2 outside
	4 KERDI-SEAL-PS	Pipe seal (3/4" - 20 mm)	1
	5 KERDI-SEAL-MV	Mixing valve seal	1
	6 KERDI-FIX	Sealing and bonding compound (66 ml)	1



* © Schluter-Systems L.P., U.S. patent No. D593,641, other patents pending

Residential Adaptor Kits - ABS Flange	
	ABS bonding flange
4" (100 mm) Square Grate	
Stainless steel (E)	KDAR/ABS/E
Oil-rubbed bronze stainless steel (EOB)	KDAR/ABS/EOB
Brushed brass anod. alu. (AMGB)	KDAR/ABS/AMGB
Brushed copper/ bronze anod. alu. (AKGB)	KDAR/ABS/AKGB
Brushed nickel anod. alu. (ATGB)	KDAR/ABS/ATGB

Flange and adaptor ring measurements - Residential

ABS		
	Standard	
A	11-13/16"	- 300 mm
B	2-13/32"	- 60.7 mm
C	2.73"	- 69.3 mm
D	5-1/4"	- 133.4 mm
E	2-29/32"	- 74 mm
F	1-1/64"	- 25.9 mm
G	2-1/16"	- 52.6 mm

DRAIN ADAPTOR KIT FOR USE WITH COMMERCIAL CLAMPING RING DRAINS - ABS

Schluter®-KERDI-DRAIN with commercial adaptor ring and ABS flange			
Includes	Description	Quantity	
	1 KERDI-DRAIN	Drain with integrated bonding flange and grate assembly	1
	2 Adaptor ring*	For commercial clamping ring drains	
	3 KERDI-FIX	Sealing and bonding compound (66 ml)	

* © Schluter-Systems L.P., U.S. patent No. D593,641, other patents pending



Commercial Adaptor Kits - ABS Flange		
	Standard ABS bonding flange	Extended ABS bonding flange
4" (100 mm) Square Grate		
Tileable covering support (ECS)*	KDA/ABS/ECS	KDA/ABSL/ECS
Stainless steel (E)	KDA/ABS/E	KDA/ABSL/E
Oil-rubbed bronze stainless steel (EOB)	KDA/ABS/EOB	KDA/ABSL/EOB
Brushed brass anod. alu. (AMGB)	KDA/ABS/AMGB	KDA/ABSL/AMGB
Brushed copper/ bronze anod. alu. (AKGB)	KDA/ABS/AKGB	KDA/ABSL/AKGB
Brushed nickel anod. alu. (ATGB)	KDA/ABS/ATGB	KDA/ABSL/ATGB
6" (150 mm) Square or Round Grate		
Square grate stainless steel (6E)	KDA/ABS/6E	KDA/ABSL/6E
Round grate stainless steel (6RE)	KDA/ABS/6RE	KDA/ABSL/6RE

* Patent pending

Flange and adaptor ring measurements - Commercial

ABS			
	Standard		Extended
A	11-13/16"	- 300 mm	11-13/16" - 300 mm
B	4-13/32"	- 111.8 mm	4-13/32" - 111.8 mm
C	4-11/16"	- 118.9 mm	4-11/16" - 118.9 mm
D	7-1/2"	- 191 mm	7-1/2" - 191 mm
E	5-7/64"	- 130 mm	5-7/64" - 130 mm
F	1-9/16"	- 39.7 mm	3-1/16" - 77.8 mm
G	2-9/64"	- 54.3 mm	3-41/64" - 92.4 mm

DRAIN ADAPTOR KIT FOR USE WITH COMMERCIAL CLAMPING RING DRAINS - STAINLESS STEEL

Schluter®-KERDI-DRAIN with commercial adaptor ring and stainless steel flange			
Includes	Description	Quantity	
 1. KERDI-DRAIN	Drain with integrated bonding flange and grate assembly	1	
2. Adaptor ring*	For commercial clamping ring drains		
 3. KERDI-FIX	Sealing and bonding compound (66 ml)		

* © Schluter-Systems L.P., U.S. patent No. D593,641, other patents pending

Commercial Adaptor Kits - Stainless Steel Flange	
	Stainless steel bonding flange
4" (100 mm) Square Grate	
Tileable covering support (ECS)*	KDA/E/ECS
Stainless steel (E)	KDA/E/E
Oil-rubbed bronze stainless steel (EOB)	KDA/E/EOB
Brushed brass anod. alu. (AMGB)	KDA/E/AMGB
Brushed copper/ bronze anod. alu. (AKGB)	KDA/E/AKGB
Brushed nickel anod. alu. (ATGB)	KDA/E/ATGB
6" (150 mm) Square or Round Grate	
Square grate stainless steel (6E)	KDA/E/6E
Round grate stainless steel (6RE)	KDA/E/6RE

* Patent pending

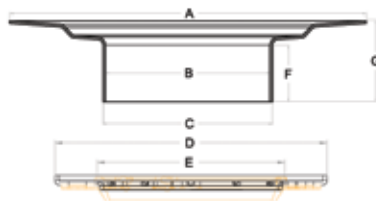
Flange and adaptor ring measurements - Commercial Stainless steel		
	Standard	
	A	9-27/32" - 250 mm
	B	4-9/16" - 115.7 mm
	C	4-11/16" - 118.7 mm
	D	7-1/2" - 191 mm
	E	5-7/64" - 130 mm
	F	1-9/16" - 39.7 mm
	G	2-3/16" - 56.5 mm

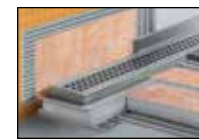

Note: There are multiple selections to be made for this product. Start by selecting the appropriate flange length then proceed to grate selection accordingly, keeping in mind there are two frame heights with two grate options (A or B), and a frameless option (D).

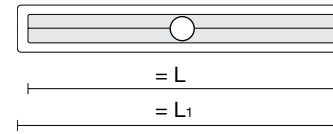

8.7 Schluter®-KERDI-LINE Bonding flange - stainless steel - center outlet

L = in. - cm	L ₁ = in. - cm	Item No.
20 - 50	22 - 55	KLVO 60 E 50
24 - 60	26 - 65	KLVO 60 E 60
28 - 70	30 - 75	KLVO 60 E 70
32 - 80	34 - 85	KLVO 60 E 80
36 - 90	38 - 95	KLVO 60 E 90
40 - 100	42 - 105	KLVO 60 E 100
44 - 110	46 - 115	KLVO 60 E 110
48 - 120	50 - 125	KLVO 60 E 120
52 - 130	54 - 135	KLVO 60 E 130
56 - 140	58 - 145	KLVO 60 E 140
60 - 150	62 - 155	KLVO 60 E 150
64 - 160	66 - 165	KLVO 60 E 160
68 - 170	70 - 175	KLVO 60 E 170
72 - 180	74 - 185	KLVO 60 E 180

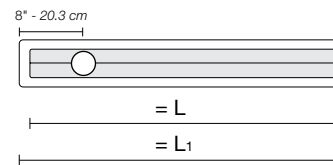

8.7 Schluter®-KERDI-LINE Bonding flange - stainless steel - off-center outlet

L = in. - cm	L ₁ = in. - cm	Item No.
28 - 70	30 - 75	KLVO 60 E 70
32 - 80	34 - 85	KLVO 60 E 80
36 - 90	38 - 95	KLVO 60 E 90
40 - 100	42 - 105	KLVO 60 E 100
44 - 110	46 - 115	KLVO 60 E 110
48 - 120	50 - 125	KLVO 60 E 120

Note : Please see page 14 for listings and certifications.

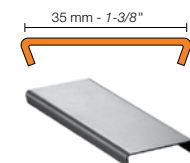

14.1 Schluter®-KERDI-LINE-FC Cover plate

Item No.	Width
V / KLEB 35	1-3/8" - 35 mm

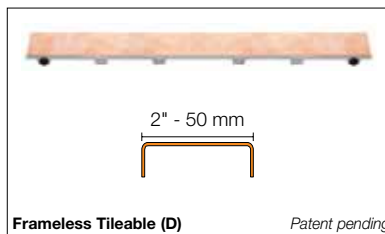
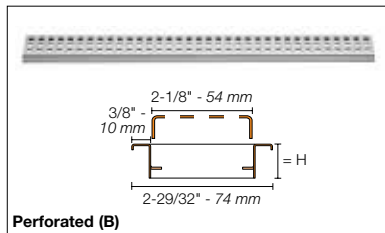
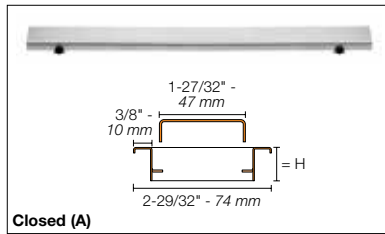

8.7 Schluter®-KERDI-LINE Grate assemblies

Length = in. - cm	Item No.		Item No.	
	Closed (A)	Perforated (B)	Frameless Tileable (D) - Patent pending	
			Center outlet	Off-set outlet
3/4" - 19 mm frame height for 1/8" to 9/16" - 3 mm to 15 mm -thick coverings				
20 - 50	KLAR 19 EB 50	KLB 19 EB 50	KLDRE 50	-
24 - 60	KLAR 19 EB 60	KLB 19 EB 60	KLDRE 60	-
28 - 70	KLAR 19 EB 70	KLB 19 EB 70	KLDRE 70	KLDRO E 70
32 - 80	KLAR 19 EB 80	KLB 19 EB 80	KLDRE 80	KLDRO E 80
36 - 90	KLAR 19 EB 90	KLB 19 EB 90	KLDRE 90	KLDRO E 90
40 - 100	KLAR 19 EB 100	KLB 19 EB 100	KLDRE 100	KLDRO E 100
44 - 110	KLAR 19 EB 110	KLB 19 EB 110	KLDRE 110	KLDRO E 110
48 - 120	KLAR 19 EB 120	KLB 19 EB 120	KLDRE 120	KLDRO E 120
52 - 130	KLAR 19 EB 130	KLB 19 EB 130	KLDRE 130	-
56 - 140	KLAR 19 EB 140	KLB 19 EB 140	KLDRE 140	-
60 - 150	KLAR 19 EB 150	KLB 19 EB 150	KLDRE 150	-
64 - 160	KLAR 19 EB 160	KLB 19 EB 160	KLDRE 160	-
68 - 170	KLAR 19 EB 170	KLB 19 EB 170	KLDRE 170	-
72 - 180	KLAR 19 EB 180	KLB 19 EB 180	KLDRE 180	-

Length = in. - cm	Item No.		Item No.	
	Closed (A)	Perforated (B)	Frameless Tileable (D) - Patent pending	
1-1/8" - 30 mm frame height for 1/2" to 1" - 13 mm to 25 mm -thick coverings				
20 - 50	KLAR 30 EB 50	KLB 30 EB 50		
24 - 60	KLAR 30 EB 60	KLB 30 EB 60		
28 - 70	KLAR 30 EB 70	KLB 30 EB 70		
32 - 80	KLAR 30 EB 80	KLB 30 EB 80		
36 - 90	KLAR 30 EB 90	KLB 30 EB 90		
40 - 100	KLAR 30 EB 100	KLB 30 EB 100		
44 - 110	KLAR 30 EB 110	KLB 30 EB 110		
48 - 120	KLAR 30 EB 120	KLB 30 EB 120		

Note: The perforated grate (B) is also available with a locking mechanism to prevent removal of the grate. For more information contact customer service at 1-800-472-4588 (US) or 1-800-667-8746 (CANADA).

Product Listings and Certifications Table

Schluter®-KERDI-DRAIN										
Bonding Flange 2" (50 mm) Outlet	Grate - 4" (100 mm)						Grate - 6" (150 mm)			
	E	EOB	AMGB	AKGB	ATGB	ECS*	6E	6RE	6CE	6RCE
ABS / PVC	1	-	1	1	1	1	1	1	2	2
Stainless steel	1	-	1	1	1	1	1	1	2	2
Bonding Flange 3" (75 mm) Outlet	Grate - 6" (150 mm)									
	6E			6RE			6CE		6RCE	
ABS / PVC	1			1			2		2	
Stainless steel	1			1			2		2	
Schluter®-KERDI-LINE										
Bonding Flange	Grate									
	A			B			D*			
Center outlet - 20" - 48" (50 cm - 120 cm)	1			1			1			
Center outlet - 52" - 72" (130 cm - 180 cm)	1			1			1			
Off-set outlet - 28" - 48" (70 cm - 120 cm)	1			1			1			

Various configurations of KERDI-DRAIN and KERDI-LINE are listed by ICC-ES (Report No. PMG-1204), UPC®, CSA, and NSF as shown in the table above.

1 - Listed by ICC-ES (Report No. PMG-1204), UPC®, CSA, and NSF.

2 - Listed by CSA

* Patent pending

For copies of these documents, please contact Schluter®-Systems at 800-472-4588 (USA) or 800-667-8746 (Canada) or by email at info@schluter.com. Links to the documents can also be accessed at www.schluter.com.

Schluter®-Systems Floor Drains 10-Year Limited Warranty

COVERAGE AND CONDITIONS: Subject to the conditions and limitations as stated hereinafter, **Schluter Systems*** warrants that **Schluter®-KERDI-DRAIN** or **Schluter®-KERDI-LINE** (the "Product") will be free from manufacturing defects, and will not rot, deteriorate or break down under normal use for a period of ten (10) years from the date of purchase only when the Product is used and installed in accordance with the terms and conditions of the Schluter®-Systems Floor Drains Technical Data Sheet and industry standard guidelines that are not in conflict with the Data Sheet in effect at the time of installation. It is the responsibility of the owner/ builder/ installer to ensure the suitability of all building materials and all associated building materials for the owner's intended use. It is recommended that the owner consult with an experienced and professional installer.

RESOLUTION: If the Product fails to meet this warranty, then the owner's exclusive remedy and the sole obligation of Schluter-Systems, at its election, shall be to a) replace the failed Product or b) pay an amount not to exceed the original cost of the Product verified to be defective. When Schluter®-KERDI-DRAIN or Schluter®-KERDI-LINE is installed in conjunction with Schluter®-DITRA or Schluter®-KERDI, the assembly qualifies for the Schluter®-DITRA & Schluter®-DITRA-XL 10-Year Limited Warranty, Schluter®-KERDI & Schluter®-KERDI-DS 10-Year Limited Warranty, or Schluter®-Shower System 10-Year Limited Warranty. The warranties referenced above cover the entire covering assembly. Refer to the Schluter®-DITRA Installation Handbook, Schluter®-Waterproofing Membranes Technical Data Sheet, and Schluter®-Shower System Installation Handbook for details and applicable warranty information.

DISCLAIMER: THERE ARE NO WARRANTIES BEYOND THIS EXPRESSED WARRANTY AS STATED ABOVE. ALL OTHER WARRANTIES, REPRESENTATIONS OR CONDITIONS, EXPRESSED OR IMPLIED, ARE DISCLAIMED AND EXCLUDED, INCLUDING WARRANTIES, REPRESENTATIONS OR CONDITIONS OF **MERCHANTABILITY** OR FITNESS FOR A PARTICULAR PURPOSE ARISING BY STATUTE OR OTHERWISE BY LAW OR FROM A COURSE OF DEALING OR USAGE OF TRADE. SCHLUTER-SYSTEMS EXCLUDES AND IN NO EVENT SHALL HAVE ANY LIABILITY FOR LOST PROFITS OR ANY OTHER INDIRECT, SPECIAL, INCIDENTAL, PUNITIVE, EXEMPLARY, OR CONSEQUENTIAL DAMAGES, ARISING OUT OF OR OTHERWISE CONNECTED TO FAILURE OF THE PRODUCT OR TILE ASSEMBLY OF WHICH IT IS PART, NOR MISUSE OF THE PRODUCT OR TILE ASSEMBLY, REGARDLESS OF ANY STRICT LIABILITY, ACTIVE OR PASSIVE NEGLIGENCE OF SCHLUTER-SYSTEMS, AND REGARDLESS OF THE LEGAL THEORY (CONTRACT OR TORT OR EXTRA-CONTRACTUAL OR OTHER), NOR FROM ACTS OF WAR, TERRORISM, FAULTY AND NEGLIGENT PENETRATION OF THE SYSTEM, FIRES, EXPLOSIONS, ACTS OF GOD, INTENTIONAL ACTS OF DESTRUCTION OR ANY LOSSES DUE TO STRUCTURAL FAILURE OR OTHER CAUSES UNRELATED TO THE PRODUCT OR DELAYS, OR ANY OTHER INCIDENTAL OR CONSEQUENTIAL DAMAGES. THIS WARRANTY IS GIVEN IN LIEU OF ANY OTHER WARRANTY EXPRESSED OR IMPLIED. THE REMEDIES CONTAINED HEREIN ARE THE ONLY REMEDIES AVAILABLE FOR BREACH OF THIS WARRANTY. THIS LIMITED WARRANTY GIVES YOU SPECIFIC LEGAL RIGHTS; SOME STATES AND PROVINCES DO NOT ALLOW DISCLAIMERS OR OTHER RESTRICTIONS OF IMPLIED WARRANTIES, SO SOME OF THE ABOVE DISCLAIMERS MAY NOT APPLY TO YOU.

TRANSFERABILITY: This Limited Warranty extends ONLY to the original end user (defined as original intended owner and user of the property/unit in which the installation is incorporated - herein referred to as "Owner") and is not transferable or assignable, unless approved in writing by the Technical Director or an Officer of Schluter-Systems or otherwise prohibited by specific state or provincial law.

MODIFICATIONS TO WARRANTY: No changes or modification of any terms or conditions of this warranty are allowed unless authorized by written agreement and signed by the Technical Director or an Officer of Schluter-Systems.

EFFECTIVE DATE: This warranty shall supersede and replace any and all prior oral or written warranties, agreements, or other such representations made by or on behalf of Schluter-Systems relative to the Product or the application of the Product and shall apply to any installation occurring on or after January 1, 2013.

CLAIMS ON THIS LIMITED WARRANTY: To make a claim under this Limited Warranty, the Owner must provide Schluter-Systems with written notice within 30 days of any alleged defect in the Product covered by this Limited Warranty, together with date and proof of purchase of the Product, proof of the costs of the original installation and name and address of all installers, failing which this Limited Warranty shall be of no legal effect. Schluter-Systems reserves the right at its election and as a condition of this Limited Warranty to inspect the alleged failed and defective condition.

All U.S. Claims shall be sent to:

All Canadian Claims shall be sent to:

Schluter Systems L.P.
Attn: Warranty Claims Dept.
194 Pleasant Ridge Road
Plattsburgh, NY 12901-5841

Schluter Systems (Canada), Inc.
Attn: Warranty Claims Dept.
21100 chemin Ste-Marie
Ste-Anne-de-Bellevue, QC H9X 3Y8

*For the purpose of this warranty **Schluter Systems, L.P.** shall provide the warranty for all products for end users located in the United States, and **Schluter Systems (Canada) Inc.** shall provide the warranty for all products for end users located in Canada. This warranty is limited to sales of the Product made in and intended for use in the United States and Canada.



Schluter Systems L.P. • 194 Pleasant Ridge Road, Plattsburgh, NY 12901-5841 • Tel.: 800-472-4588 • Fax: 800-477-9783
Schluter Systems (Canada) Inc. • 21100 chemin Ste-Marie, Ste-Anne-de-Bellevue, QC H9X 3Y8 • Tel.: 800-667-8746 • Fax: 877-667-2410
info@schluter.com

www.schluter.com